

Furniture collection

enea

enea

Index

About Enea.....	01
Kua.....	07
Leku.....	27
Mate.....	45
Lore.....	89
Taber.....	117
Tema.....	127
Kubika.....	137
Noa.....	153
Kide.....	179
Puck.....	187
Iron.....	203
Pile.....	213
Kaiak.....	223
Street.....	253
Caddy.....	267
LTS.....	277
Ema.....	295
Way.....	315
Folio.....	325
Lottus.....	335
Lottus Kids.....	403
Lottus AL.....	409
Conference.....	417
Oh!.....	431
Bio.....	445
Coma.....	459
Punto.....	477
Eina.....	485
Designers.....	503

Inspired by life, made by enea

At Enea, we find inspiration in every aspect of daily life when we design and create our premium furniture. Our beautiful, strong, and sustainable pieces travel to all corners of the globe from our factory in the Basque Country, to keep you company while you are eating, chatting, or working. While you are waiting, sharing, or relaxing.

En Enea, diseñamos y fabricamos mobiliario premium inspirándonos en cómo vivimos hoy en día. Desde nuestra fábrica del País Vasco viajan a todo el mundo muebles fuertes, estéticos y sostenibles que nos acompañan a la hora de comer, conversar y trabajar. A la hora de esperar, compartir y descansar.



From 1984

Enea has been part of the history of Spanish design since the 1980s. The brand was born in 1984 in the Goierri area (Gipuzkoa) with the clear mission of designing and manufacturing furniture inspired by people's lives. In fact, the Basque word *enea* can be translated as "the house of" and is a common word ending that is used in the names of farmhouses and family houses across the Basque Country.

Desde 1984

Enea forma parte de la historia del diseño español desde la década de los ochenta. La marca nació en 1984 en la zona del Goierri (Gipuzkoa) con la clara misión de diseñar y fabricar mobiliario inspirándose en la vida de las personas. De hecho, en euskera "Enea" podría traducirse como "la (casa) de", y es una terminación común en nombres de caseríos y casas del País Vasco.

Together is better

Enea represents a unique milestone in Spanish design, as it was created –and continues to work– as a cooperative. This means that many of the staff members are also the owners of the project. Cooperation is part of our DNA; and constant cooperation is fundamental in the way we work with designers, consultants, distributors, and architects to progress from a base of commitment with a set of shared values. Enea is part of the Mondragon Corporation, which is one of the largest industrial groups in Spain.

Juntos es mejor

Enea supone un hito singular en el diseño español, ya que se creó —y sigue funcionando— como una cooperativa. Es decir, gran parte de los trabajadores somos propietarios de la empresa. Así que la cooperación forma parte de nuestro ADN; y cooperar, cooperar y cooperar es la única manera que entendemos de trabajar con diseñadores, prescriptores, distribuidores o arquitectos para avanzar desde el compromiso con unos valores compartidos. Enea forma parte de la Corporación Mondragon, uno de los mayores grupos industriales de España.

Naturally sustainable

Sustainability is a non-negotiable requirement in the briefing of any new design. Since our very beginning, we have understood sustainability in a global way. And not only through investigation and research so we can use more natural or recyclable materials, but also from the viewpoint of durability, robustness, and quality. Because what's more sustainable than something that lasts for 20 years instead of 5? At Enea, whilst we acknowledge that we still have a long way to go, we are constantly striving to find more sustainable and responsible solutions that provide the world with alternatives to improve and care for it.

Naturalmente sostenibles

La sostenibilidad es un requisito innegociable en el briefing de cualquier nuevo diseño. Desde nuestros inicios hemos entendido la sostenibilidad de una forma global. No solo explorando e investigando para usar materiales más naturales o que se pueden reciclar. También desde la durabilidad, la robustez, la calidad. ¿Qué hay más sostenible que algo que te dura 20 años en vez de 5 años? En Enea, y bajo la premisa de que tenemos todavía mucho camino de mejora, no cesamos en nuestro empeño de buscar siempre soluciones más sostenibles y responsables que aporten al mundo alternativas para mejorarlo y cuidarlo.

A personal point of view

We believe that design needs to go hand in hand with authenticity. That is why we have always wanted to give our personal vision to the world of design. Not only for you to get a little closer to the Basque Country through our chairs, tables, stools..., or for the Basque Country to be ever more present in the world; but because we believe that uniqueness, a different way of looking at things, and a distinctive character are all necessary values for what we call iconicity.

Una mirada propia

Creemos que el diseño tiene que ir unido a la autenticidad. Por eso, y desde nuestros inicios, hemos querido aportar una mirada propia al mundo del diseño. No solo para que puedas acercarte un poco al País Vasco a través de nuestras sillas, mesas, taburetes... o para que el País Vasco pueda estar todavía más presente en el mundo, sino porque creemos que la singularidad, las miradas diferentes, el carácter propio, son un valor necesario para eso que llamamos iconicidad.

Kua

By Estudi Manel Molina

Kua has been designed to envelop you in a sense of relaxation that invites you to disconnect before reconnecting again.

Its elegant contemporary design, combined with premium materials and the 'made by enea' high-quality craftsmanship, will transport you to a world of calmness and sophistication.

This is the perfect retreat to create inspiring moments.

Kua ha sido diseñada para envolverte en una sensación de relax que te invite a desconectar para volver a conectar.

Su elegante diseño contemporáneo, combinado con calidad de fabricación 'made by enea' y materiales premium, te transportarán a un mundo de calma y sofisticación. El refugio perfecto para vivir momentos inspiradores.

Kua Lounge





Kua lounge in Sand RAL 7032 with a fully upholstered shell in Main Line Flax MLF17 and a grey seam.
Taber rounded side table h37cm in Grey RAL 7004 with rounded melamine oak table top.







Kua lounge in Mustard Pantone 1245 with a fully upholstered shell in Main Line Flax MLF20 and a grey seam.
Lottus rounded-square table bases in Mustard Pantone 1245 with rounded melamine oak table top.

Kua Ottoman





Kua lounge and ottoman in Black RAL 9005 with a fully upholstered shell in Main Line Flax MLF36 and a black seam.
Kua side table 4L in Black RAL 9005 with natural oak table top.

Kua Side Table





Kua side table 4L in Black RAL 9005 with natural oak table top.
Kua lounge and ottoman in Black RAL 9005 with a fully upholstered shell in Main Line Flax MLF12 and a black seam.

Kua Lounge Chair

Kua Lounge Chair 4R Revolving

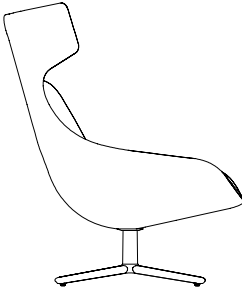

Kua Ottoman

Kua Ottoman 4R

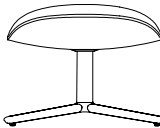

Kua Side Tables

Kua Side Table 3L

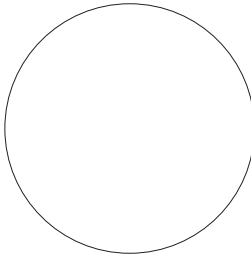
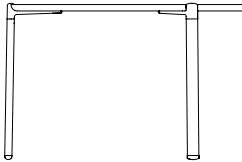

Kua Side Table 4L

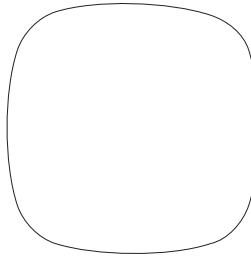
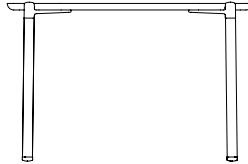

Lounge Chair & Ottoman Shells

Fully upholstered



Fully upholstered

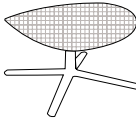

Learn more about the collection by scanning this QR code.



Leku

By Estudi Manel Molina

Leku has been designed to become a reference chair for environments that require style, versatility, and durability. Its ergonomic frame and wide range of customisation options not only guarantee an outstanding aesthetic experience, but also give you free rein to unleash your imagination.

Leku ha sido diseñada para convertirse en una silla de referencia para entornos que requieren de estilo, versatilidad y durabilidad. Su estructura ergonómica y su amplia gama de opciones de personalización garantizan no solo una experiencia estética excepcional, sino que puedas dar rienda suelta infinita a tu imaginación.

Leku 4L





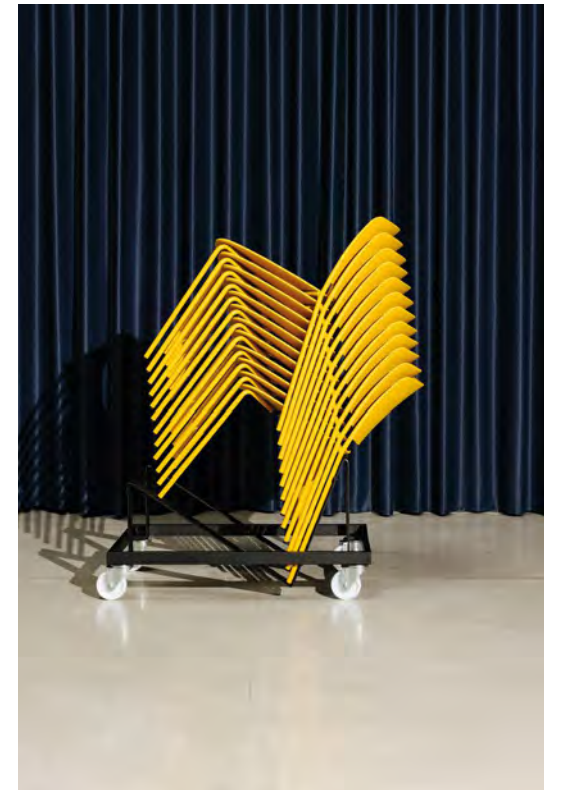







Leku 4L chair in Sand RAL 7032 with polypropylene shell in Ocean PP031.
LTS rounded-square table bases h73cm in natural oak with rounded-square oak table top.





Leku 4L chair in Ocean Pantone 7545 with polypropylene shell in Sky PP032.

Leku Chair

Leku Chair 4L

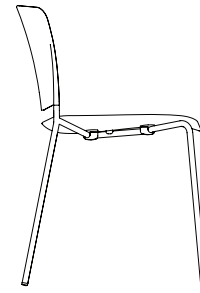

Shell

Polypropylene shell

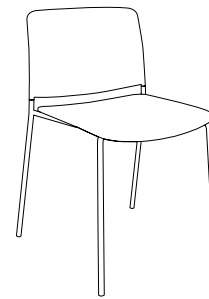

Learn more about the collection
by scanning this QR code.



Mate

By Estudi Manel Molina

The Mate collection is the epitome of versatility. Available in chair and stool, it has been designed to create multiple configurations, making it the perfect collection for any setting. Mate is undoubtedly a great ally to help create authentic, functional, and sustainable spaces which are inspired by daily life.

La colección Mate es todo un ejemplo de versatilidad. Disponible en silla y taburete, su diseño permite crear infinitas configuraciones, convirtiéndola en la colección ideal para cualquier contexto. Sin duda, Mate es una gran aliada para crear espacios funcionales, sostenibles y auténticos que se inspiren en la vida de hoy.

Mate C

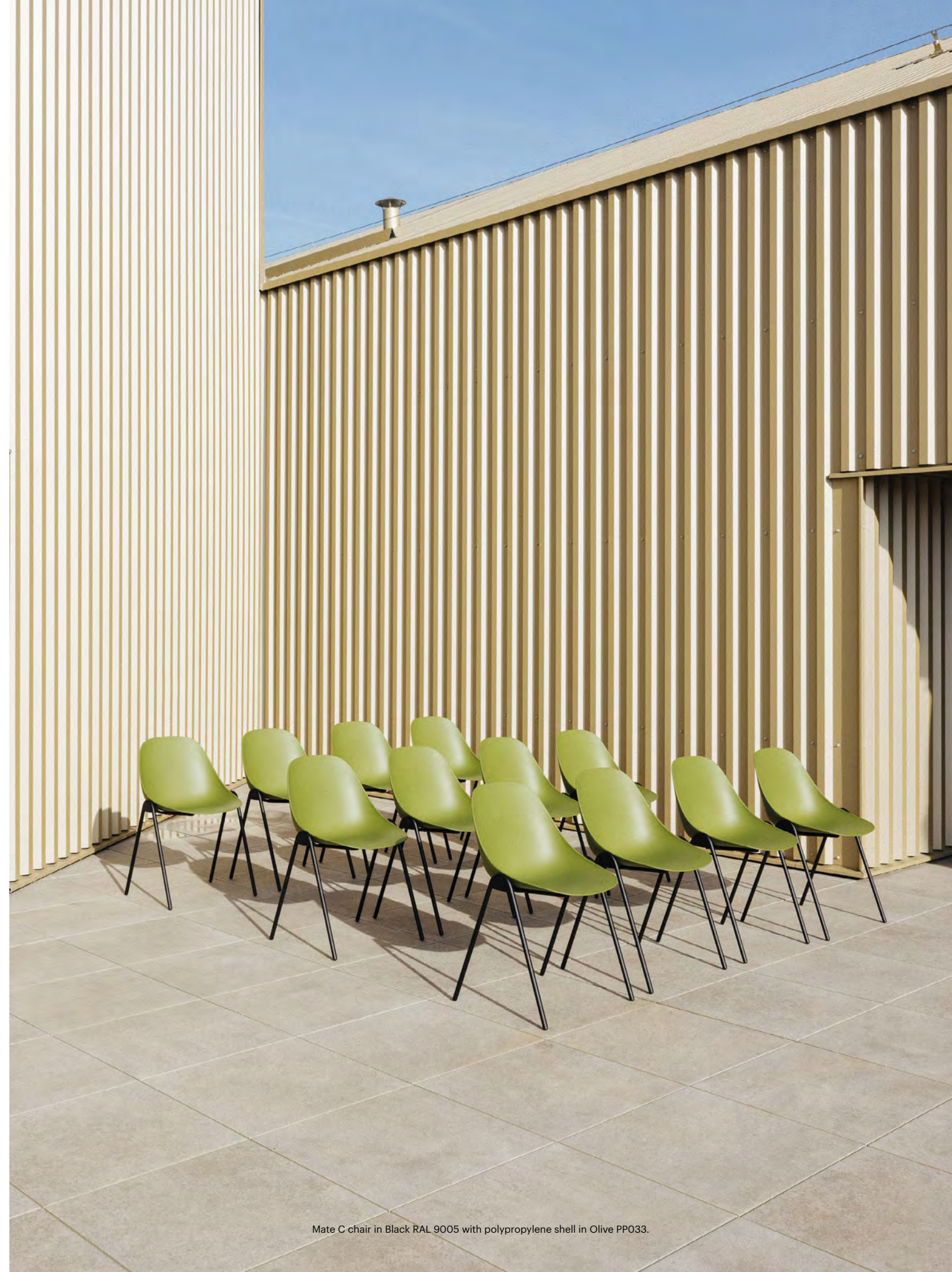

Mate





Mate C chair in Black RAL 9005 with a fully upholstered shell in Tonus 454.

Mate



Mate 4L Wood





Mate 4R





Mate Spin





Mate Spin chair in Black RAL 9005 with polypropylene shell in Olive PP033 and pad upholstered in Canvas 964. Mate C chair in Black RAL 9005 with a fully upholstered shell in Canvas 964.

Mate Spin Wood

Mate Spin Wood chair with a fully upholstered shell in Re-wool 358.
Taber rounded table bases h73cm in Black RAL 9005 with oak rounded table top.



Mate 5R



Mate Spin Stool





Mate



Mate Sledge Stool

Mate Sledge stackable stool in Teja Pantone 174 with polypropylene shell and pad in Teja PP036.
Pile table bases h110cm in Teja Pantone 174 with HPL oak round table top.





Mate 4L Wood Stool

Mate 4L Wood stool with a fully upholstered high shell in Xtreme YS097.



Mate Spin Wood Stool





Mate Lift Stool





Mate Lift stool in Sand RAL 7032 with a fully upholstered high shell and pad in Valencia Cashmere 107-2117.



Mate Chairs

Mate Chair C

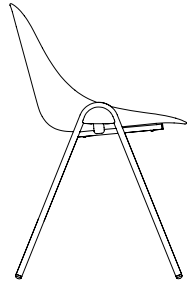

Mate Chair 4L Wood

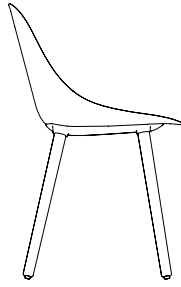

Mate Chair 4R Fix & Swivel

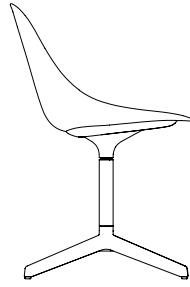

Mate Chair 4R Fix with wheels

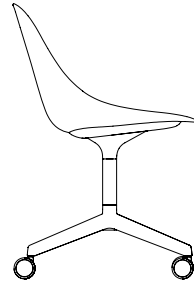

Mate Chair Spin & Swivel

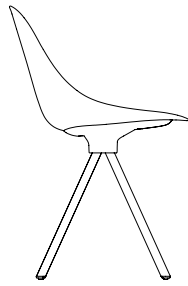

Mate Chair Spin Wood

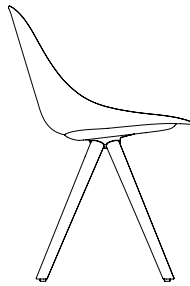

Mate Chair 5R

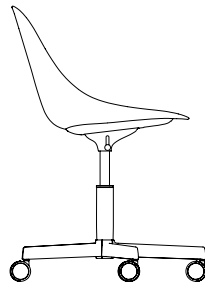

Chair Shells

Polypropylene shell

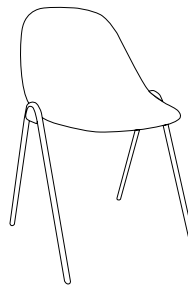

Polypropylene shell + upholstered pad

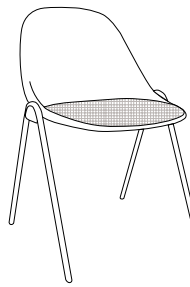

Fully upholstered

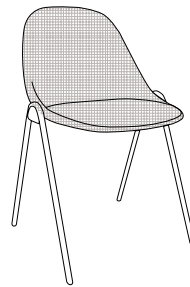

Mate Stools

Mate Stool Spin Medium & High

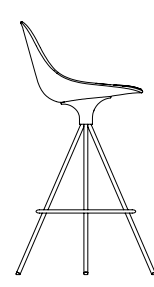

Mate Stool Sledge Medium & High



Mate Stool Sledge Stackable High



Mate Stool 4L Wood Medium & High

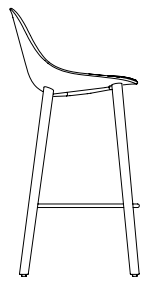

Mate Stool Spin Wood Medium & High

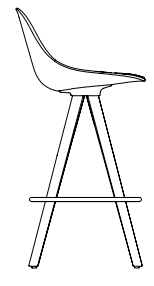

Mate Stool Lift

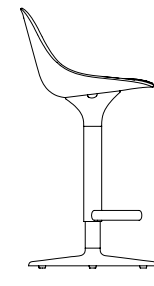

Stool Shells

Polypropylene high shell + pad

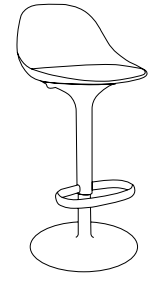

Polypropylene high shell + upholstered pad

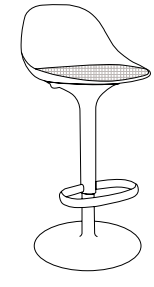

Fully upholstered high

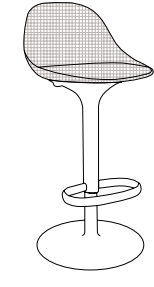

Polypropylene shell + pad

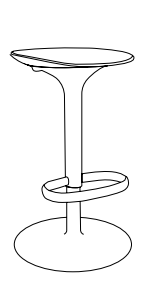

Polypropylene shell + upholstered pad

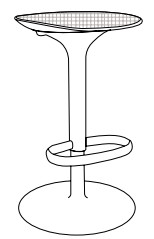

Learn more about the collection
by scanning this QR code.



Lore

By Estudi Manel Molina

Comfort and elegance come together in perfect harmony in the Lore collection. Its organic lines create an enveloping piece of great beauty. The wide variety of available materials and finishes provides the opportunity to create multiple configurations that easily adapt to any functionality or environment.

La comodidad y elegancia se unen en perfecta armonía en la colección Lore. Sus formas orgánicas crean una pieza envolvente de gran belleza. La amplia variedad de materiales y acabados disponibles brinda la oportunidad de crear múltiples configuraciones que se adaptan a cualquier funcionalidad y ambiente.

Lore 4L





Lore Sledge

Lore Sledge chair in Teja Pantone 174 with polypropylene shell in Teja PP036 and pad upholstered in Divina MD 203.





Lore 4L Wood





Lore 4L Wood chair with a fully upholstered shell in Clara 388.

Lore 4R



Lore Spin





Lore Spin chair in Sand RAL 7032 with polypropylene shell in Sand PP015 and pad upholstered in Clara 427.



Lore Spin Wood





Lore 5R



Lore Chairs

Lore Chair 4L with arms

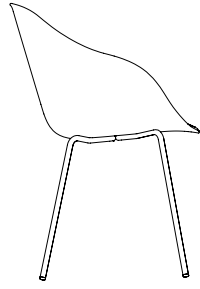

Lore Chair Sledge with arms

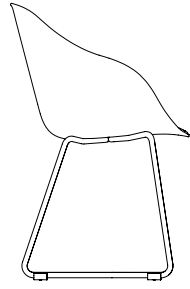

Lore Chair 4L Wood with arms

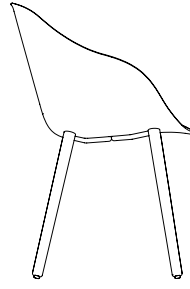

Lore Chair 4R Fix & Swivel with arms

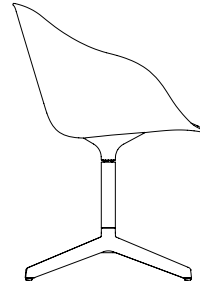

Lore Chair 4R Fix with arms and wheels

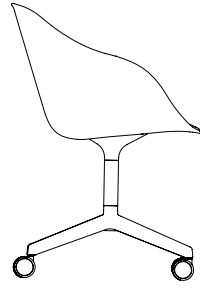

Lore Chair Spin Fix & Swivel with arms

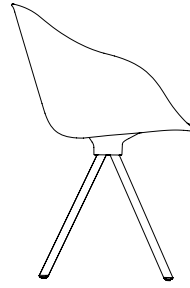

Lore Chair Spin Wood with arms

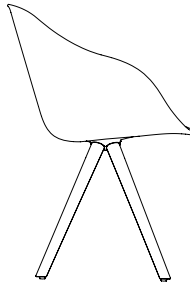

Lore Chair 5R with arms

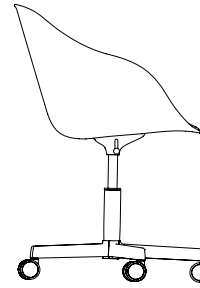

Shells

Polypropylene shell + pad

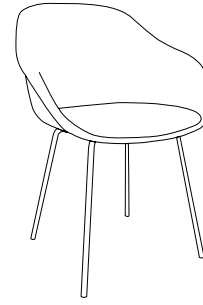

Polypropylene shell + upholstered pad

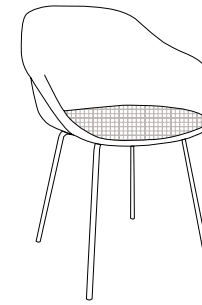

Fully upholstered

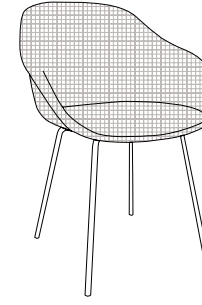

Learn more about the collection
by scanning this QR code.



Taber

By Estudi Manel Molina

Taber is an elegant and versatile table that's ready to be part of cafés, work environments, and many other places that want to be adapted to today's life. It is available in two different heights and features a unique wooden frame.

La mesa Taber es una mesa elegante y versátil, dispuesta a ser parte de cafeterías, entornos de trabajo y, en general, de lugares que se quieren adaptar a la vida de hoy. Dispone de dos alturas y una estructura de madera que la hace única.

Taber Side Table





Taber Table Bases



Taber rounded table bases h73cm in Black RAL 9005 with oak rounded table top.
Mate Spin Wood chair with a fully upholstered shell in Re-wool 358.



Taber Table Bases

Taber Side Table Square

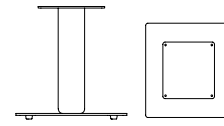

Taber Side Table Rounded-square

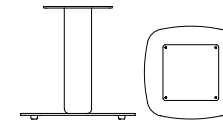

Taber Side Table Round

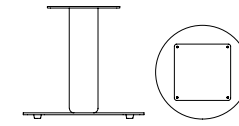

Taber Table Bases Square

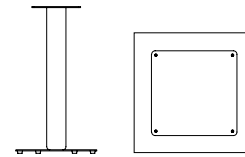

Taber Table Bases Rounded-square

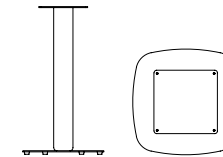

Taber Table Bases Round

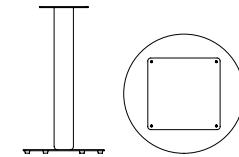

Enea Small Table Tops

Enea Small Table Top Square

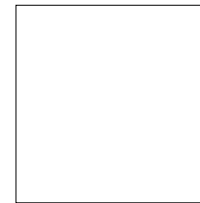

Enea Small Table Top Rounded-square

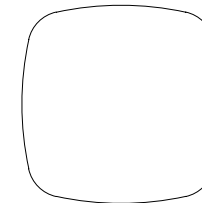

Enea Small Table Top Round

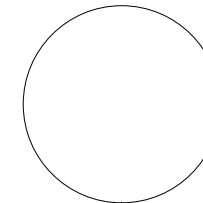

Learn more about the collection
by scanning this QR code.



Tema

By Estudi Manel Molina

Tema is a highly stackable table conceived for multipurpose and functional spaces that need to be assembled and disassembled in the blink of an eye. Robust and with gentle contours, this piece has been designed to respond to the different needs that arise every day in training rooms, universities, and schools.

Tema es una mesa de gran apilabilidad pensada para espacios polivalentes y altamente funcionales que deben pasar, en un abrir y cerrar de ojos, de ser una cosa a ser otra. Robusta y de líneas amables, ha sido diseñada para dar respuesta a las diferentes necesidades que van surgiendo, cada día, en aulas de formación, escuelas o universidades.

Tema Table





↗
03
Faculty room
Showrooms



Tema Sledge table h74cm in Black RAL 9005 with Fenix rectangular table top in white.
Tema Sledge table h74cm in Mustard Pantone 1245 with Fenix rectangular table top in white.



Tema Table

Tema Table Sledge h74cm

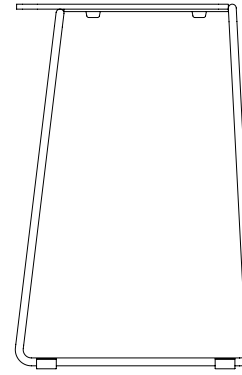

Learn more about the collection
by scanning this QR code.



Kubika

By Estudi Manel Molina

Kubika is soft, spacious, and robust. This is a modular seating system that lets you create unlimited configurations through the combination of individual modules and accessories that are easily assembled. Its versatility and sophisticated design with simple lines make it highly adaptable to any environment or to any specific needs, ranging from a sofa configuration to a waiting bench.

Kubika es suave, amplia y robusta. Un sistema de asientos modulares que permite crear configuraciones ilimitadas a través de módulos y accesorios individuales fácilmente ensamblables. Su versatilidad y su diseño sofisticado de líneas sencillas permite que pueda adaptarse a cualquier entorno y necesidad: desde una sala de espera hasta el área social de un espacio corporativo.

Kubika Modular Benches





Different Kubica configurations in Black RAL 9005 with fully upholstered shells in Divina Melange 3 871.





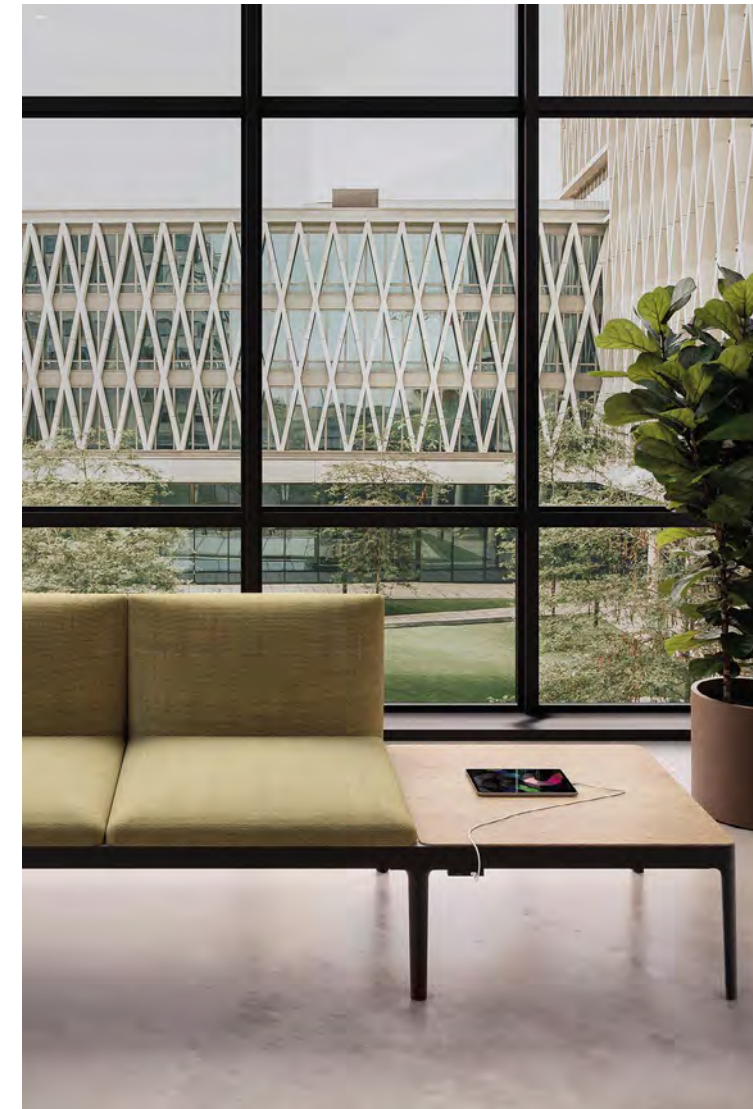

Different Kubika configurations with fully upholstered shells in Remix 3 923, 223 and 672 with Black RAL 9005 frames.
Puck pouf h37cm and h47cm in Black RAL 9005 fully upholstered in Remix 3 923 and 223. Iron rounded-square table bases h37cm
in Black RAL 9005 with rounded oak table top.



3 seater Kubika with a fully upholstered shell in Remix 173 and 223; rectangular oak union table;
4 seater Kubika with backrest and a fully upholstered shell in Remix 3 823; and oak table top. All in Black RAL 9005.

Puck pouf h37cm in Black RAL 9005 with a fully upholstered shell in Remix 3 906.
KaiaK Spin Wood lounge with arms and a fully upholstered shell in Step Melange 60004.





Kubika Modular Benches

Kubika Modular Benches 1 module

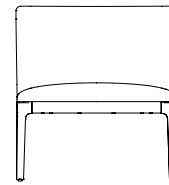

Kubika Modular Benches 2 module

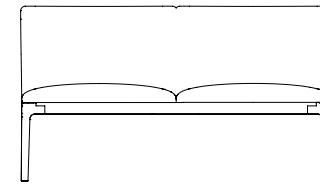

Kubika Modular Benches 3 module

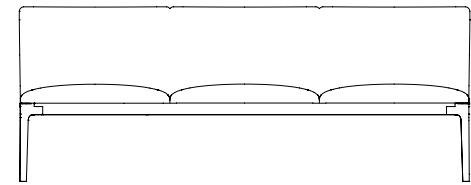

Shells

Table

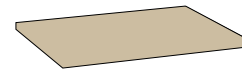

Seat



Seat + back

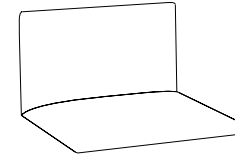

Seat + back + left arm

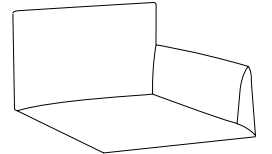

Seat + back + right arm

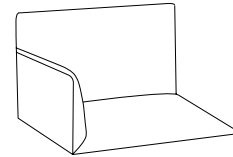

Seat + back + arms

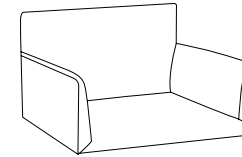

Seat with right angle backrest

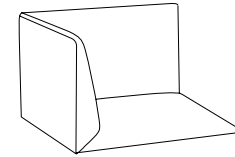

Seat with left angle backrest

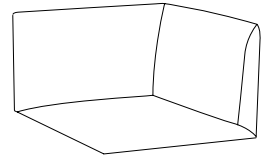

Learn more about the collection
by scanning this QR code.



Noa

By Estudi Manel Molina

The Noa collection represents a contemporary version of the classic Bistro chair. Made of lightweight materials that facilitate its stackability and manageability. Its modern design and friendly lines make this an iconic piece; and its great range of finish options means it can be adapted to all kinds of domestic and hospitality spaces.

La colección Noa parte de una versión contemporánea de la clásica silla Bistro. Está fabricada en materiales ligeros que permiten y facilitan su apilabilidad y manejabilidad. Su diseño moderno y de líneas amables hacen de ella un objeto icónico y la variedad de sus acabados permiten que se adapte a todo tipo de espacios domésticos o de restauración.

Noa 4L Wood





Noa 4L Wood chair with polypropylene backrest and seat in Mustard PP038.
Pile table bases h73cm in Mustard Pantone 1245 with HPL oak rounded table top.



Noa 4L Wood chair with polypropylene backrest and seat in Olive PP033.
Way table bases h75cm in Olive Pantone 5753 with HPL oak table top.



Noa 4L Wood chair with polypropylene backrest and seat in Teja PP036.
Iron rounded-square table bases h73cm in Teja Pantone 174 with rounded melamine oak table top.



Noa 4L Wood chair with polypropylene backrest and seat in Sand PP015.



Noa





Noa 4L Wood chair with polypropylene backrest in Ocean PPO31 and upholstered pad in Silk SLK18.
LTS rounded-square table bases h73cm in natural oak with rounded-square oak table top.





Noa 4L Wood chair with a fully upholstered shell in Seattle ES047.
LTS rounded-square table bases h73cm in natural oak with LTS rounded-square oak table top.



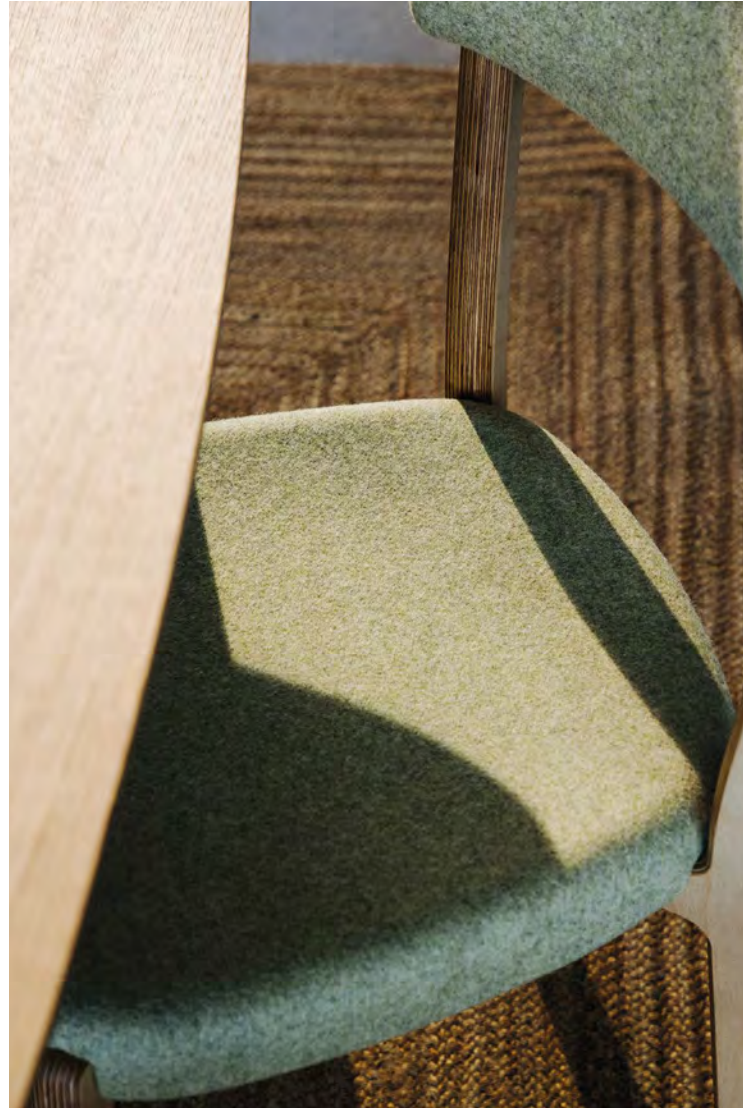

Noa 4L Wood Stool

Noa 4L Wood stool high with polypropylene backrest and seat in White PP003.
Iron rounded-square table bases h110cm in White RAL 9016 with melaminé oak rounded table top.



Noa 4L Wood stool medium, with a fully upholstered shell in Silvertex 2105.



Noa





Noa 4L Wood stool high with a fully upholstered shell in Fame 63076.
Noa 4L Wood chair with a fully upholstered shell in Silk SLK01.
LTS rounded table bases h73cm and h110cm in natural oak, with rounded oak table top.

Noa Chair

Noa 4L Wood Chair

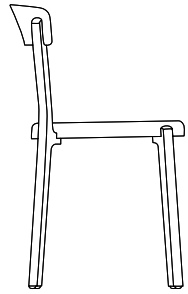

Chair Shells

Polypropylene backrest + polypropylene seat

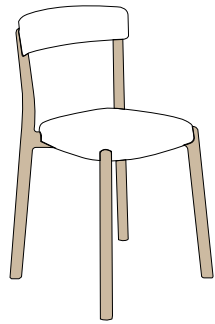

Polypropylene backrest + polypropylene pad

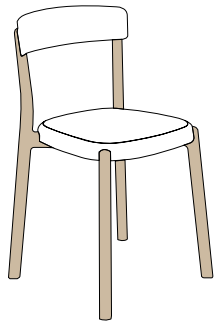

Polypropylene backrest + upholstered pad

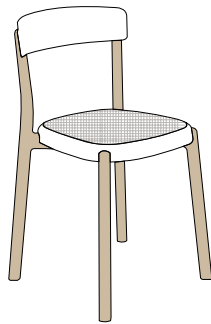

Upholstered backrest + Upholstered pad

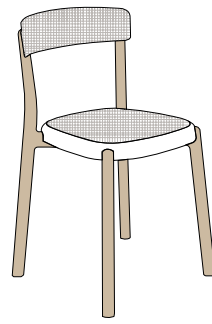

Fully Upholstered

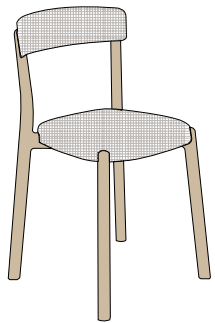

Noa Stool

Noa 4L Wood Stool Medium & High

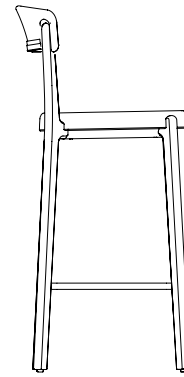

Stool Shells

Polypropylene backrest + polypropylene seat

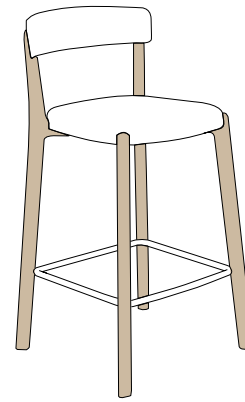

Polypropylene backrest + polypropylene pad

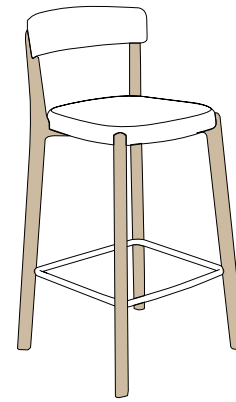

Polypropylene backrest + upholstered pad

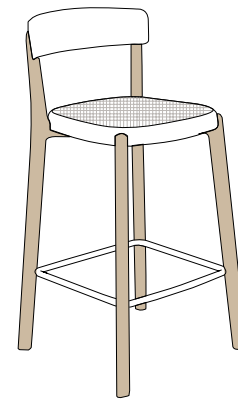

Upholstered backrest + Upholstered pad

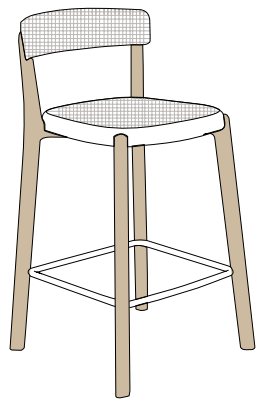

Fully Upholstered

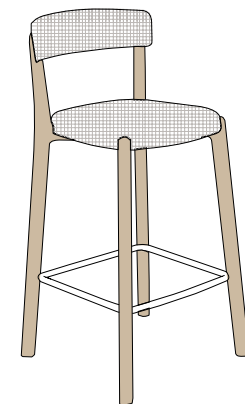

Learn more about the collection
by scanning this QR code.



Kide

By Estudi Manel Molina

Kide is a side table that has been designed to be part of contemporary life. Its sleek and robust lines contrast with its lightness to assume different functions in different spaces. Versatile, functional, and with a refined appearance, Kide is much more than just a table: it is the perfect complement to any environment.

Kide es una mesa auxiliar diseñada para acompañarte en la vida contemporánea. Su diseño elegante y robusto contrasta con su ligereza para asumir diferentes funciones en distintos espacios. Versátil, funcional y con una estética cuidada al detalle, Kide es mucho más que una mesa: es el complemento perfecto para cualquier entorno.

Kide Side Table





Kide side table h65cm in White RAL 9016 with HPL table top in black.
Puck pouf 110cm in White RAL 9016 with a fully upholstered shell in Blazer CUZ58.





Kide Side Table

Kide Side Table h650

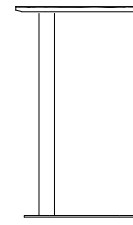

Kide side table h65cm in White RAL 9016 with HPL table top in black.
Kua lounge in Sand RAL 7032 with a fully upholstered shell in Main Line Flax MLF67 and a grey seam.

Learn more about the collection
by scanning this QR code.



Puck

By Estudi Manel Molina

With its wide range of upholstery and finish options, Puck is a bold and modern collection that lets you provide a touch of colour to any space that refuses to be merely ordinary. Its base is available with castors to add dynamism to the seat, creating a piece that's as functional as it is iconic.

Con una amplia variedad de tapicerías y acabados, Puck es una colección osada y moderna que ayudará a dar un toque de color a cualquier espacio que no quiera ser un espacio cualquiera. La base está disponible con ruedas para dar dinamismo al asiento, creando una pieza tan funcional como icónica.

Puck Pouf

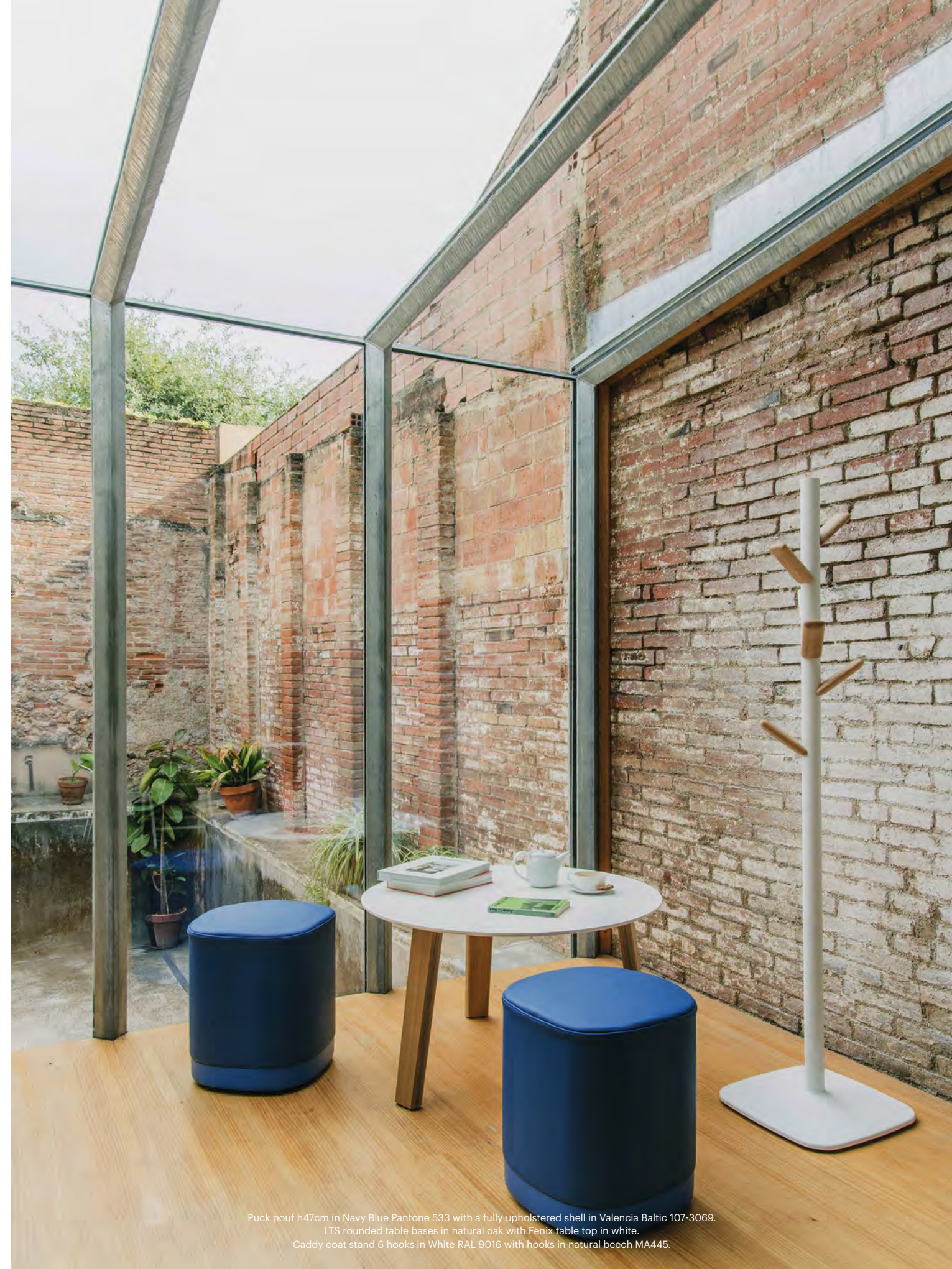



Puck pouf h47cm in Ocean Pantone 7545 with a fully upholstered shell in Plus FR PLA035.
LTS rounded-square table bases in natural oak with LTS rounded-square oak table top.
Lottus 4L chair in Ocean Pantone 7545 with a fully upholstered shell in Plus FR PLA035.





Puck pouf h47cm in White RAL 9016 with a fully upholstered shell in Advantage AD029. Puck pouf h47cm in Black RAL 9005 with a fully upholstered shell in Crisp 4033. LTS wing table bases h73cm in natural oak with HPL wing table top in white. Conference chair in Black RAL 9005 with a fully upholstered shell in Advantage AD118.





Puck pouf 110cm in Black RAL 9005 with a fully upholstered shell in Blazer CUZ1R. Puck pouf h37cm in Grey RAL 7004 with a fully upholstered shell in Divina 224 & Puck pouf h47cm in Grey RAL 7004 with a fully upholstered shell in Divina 173. Iron table bases h37cm in White RAL 9016 with HPL rounded table top in black.



Puck pouf h37cm in Grey RAL 7004 with a fully upholstered shell in Blazer CUZ1J & Puck pouf h47cm in White RAL 9016 with a fully upholstered shell in Blazer CUZ58. Puck poufs 130cm in White RAL 9016 with fully upholstered shells in Blazer CUZ1E & Blazer CUZ47. Puck pouf 110cm in White RAL 9016 with a fully upholstered shell Blazer CUZ58.



Puck Pouf

Puck Pouf h370



Puck Pouf h470

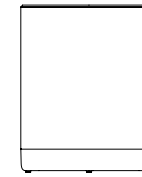

Puck Pouf 1300x550x440

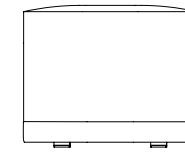

Puck Pouf 1400x800x440

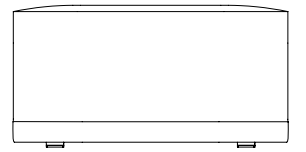

Puck Pouf 1100x1100x440

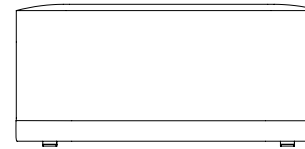

Shells

Fully upholstered

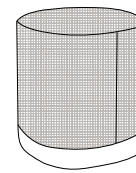

Learn more about the collection
by scanning this QR code.



Iron

By Estudi Manel Molina

The Iron table collection features an elegant architectural base that is as solid as it is beautiful. This lacquered steel base provides absolute stability, whilst the different heights and shapes provide multiple options to decorate with functionality, elegance, and timelessness.

La colección de mesas Iron cuenta con una elegante base arquitectónica tan sólida como bella. La base de acero lacado proporciona una estabilidad absoluta, mientras que las distintas alturas y formas aportan múltiples opciones a la hora de decorar con funcionalidad, elegancia y atemporalidad.

Iron Table Bases





Iron table bases h73cm in Black RAL 9005 with oak round table top.
Kaiak 4L Wood chair with wooden shell and upholstered cushion in Blazer CUZ2Q.





Iron Table Bases

Iron Table Bases Rounded-Square
41,2x41,2cm

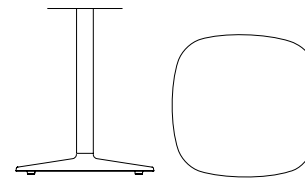

Iron Table Bases Rounded-Square
51,1x51,1cm

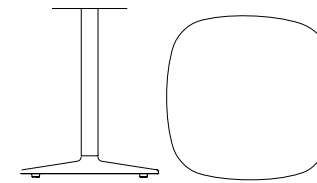

Enea Small Table Top

Enea Small Table Top Square

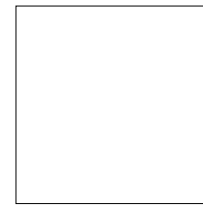

Enea Small Table Top Rounded-square

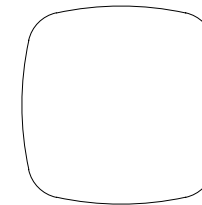

Enea Small Table Top Round

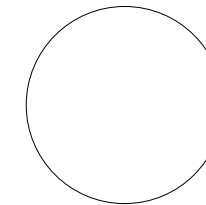

Learn more about the collection
by scanning this QR code.



Pile

By Estudi Manel Molina

A collection of tables whose design offers outstanding functionality without compromising on form. In addition to its amazing looks, the Pile base, with its distinctive design, offers full stability with an exclusive folding mechanism that helps you to effortlessly fold the tables for easy storage. Pile is therefore ideal for dynamic and highly demanding settings both indoors and outdoors.

Una colección de mesas cuyo diseño ofrece una funcionalidad excepcional sin renunciar a la forma. Además de su magnífica estética, la base Pile ofrece una total estabilidad con un mecanismo de plegado exclusivo que permite abatir las mesas sin esfuerzo para guardarlas. Por ello, Pile es la opción ideal para entornos dinámicos.

Pile Table Bases

Pile table bases h110cm in White RAL 9016 with HPL white round table top.
Street 4L stool in Sand RAL 7032.





Pile table bases h110cm in White RAL 9016 with HPL white round table top.
Street 4L stool in Sky Pantone 5435.



Pile table bases h73cm in White RAL 9016 with HPL white rounded square table top.
Pile table bases h110cm in White RAL 9016 with HPL white round table top.

Street 4L stool in Sky Pantone 5435. Street 4L chair in Sand RAL 7032. Street 4L chair with arms in White RAL 9016.





Pile Table Bases

Pile Table Bases 4R Ø703,5

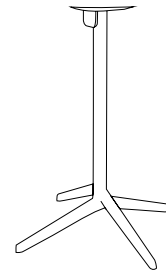

Enea Fold Table Top

Enea Fold Table Top Square



Enea Fold Table Top Rounded-square

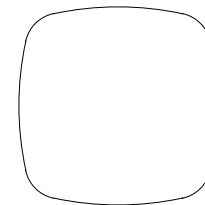

Enea Fold Table Top Round

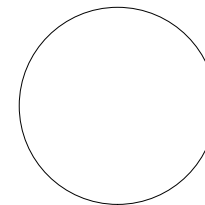

Learn more about the collection
by scanning this QR code.



Kaiak

By Estudi Manel Molina

Immerse yourself in a world of natural elegance with Kaiak. Moulded wood is the protagonist of a collection that combines subtly curved oak with high quality upholstery to create a seat that's as cosy and attractive as it is sophisticated and distinguished. Kaiak comfortably adapts to both domestic spaces and professional and public environments.

Kaiak nos sumerge en el mundo de la elegancia natural. La madera moldeada es la protagonista de esta colección que combina roble sutilmente curvado con tapicería de alta calidad para hacer de Kaiak un asiento acogedor y atractivo a la par que sofisticado y distinguido. Esta colección se adapta con comodidad a espacios domésticos y a entornos profesionales y públicos.

Kaiak 4L Wood



Kaiak 4L Wood chairs in wooden shell and upholstered cushion in Blazer CUZ2Q.
Iron table bases h73cm in Black RAL 9005 with rounded oak table top.



Kaiak Spin



Kaiak Spin Wood





Kaiak 4R

Kaiak 4R chair with wheels, in Black RAL 9005 with wooden shell upholstered 3/4 in Blazer CUZ1E and upholstered cushion in Blazer CUZ1E.
Kaiak 4R chair with wheels, in Black RAL 9005 with wooden shell upholstered 3/4 in Blazer CUZ67 and upholstered cushion in Blazer CUZ67.



Kaiak 4R chair with wheels, in Black RAL 9005 with wooden shell upholstered 3/4 and upholstered cushion in Divina 584, Blazer CUZ1E, Blazer CUZ67, Main Line Flax MLF12 and Divina 652. Punto table bases h73cm in White RAL 9016 with Fenix rounded table top in white.



Kaiak



Kaiak Office 5R





Kaiak Lounge Spin Wood



Kaiak Lounge 4R





Kaiak 4R lounge in Black RAL 9005 with wooden shell and upholstered cushion in Advantage AD098.

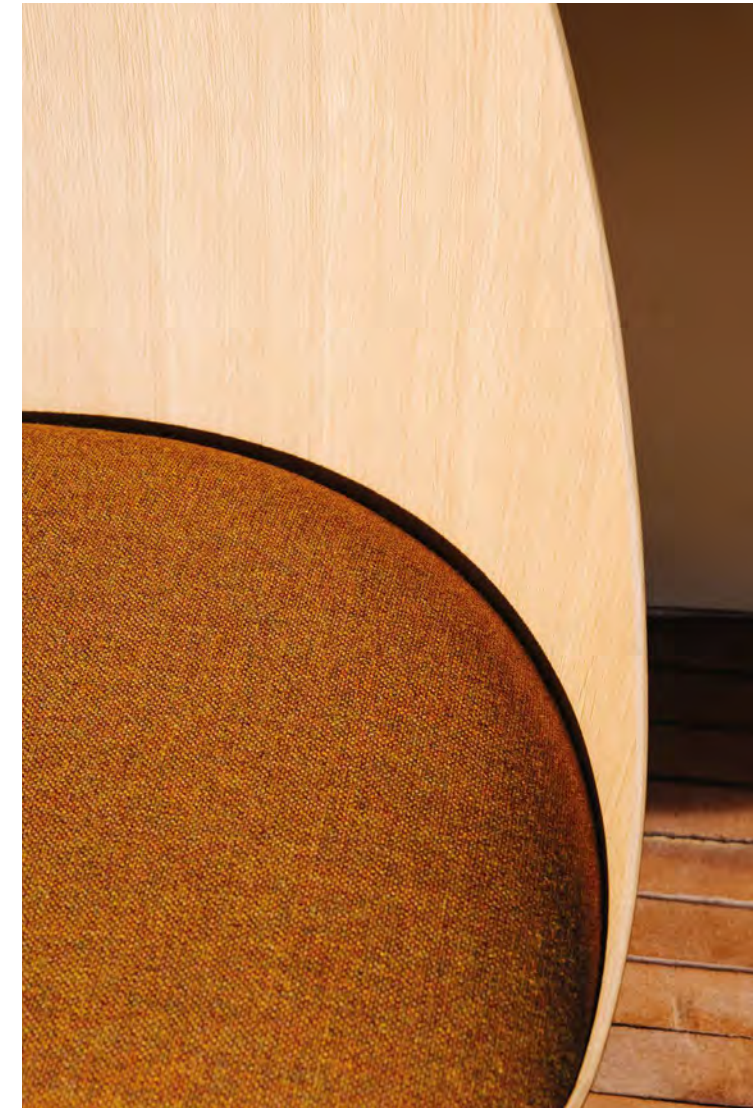



Kaiak Chairs

Kaiak Chair 4L Wood

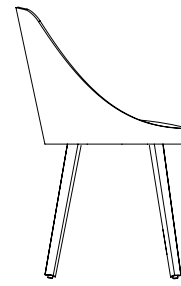

Kaiak Chair 4L Wood with arms

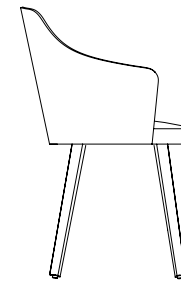

Kaiak Chair Spin Fix & Swivel

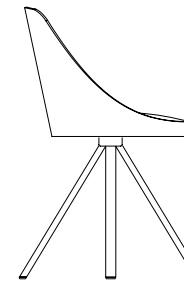

Kaiak Chair Spin Fix & Swivel with arms

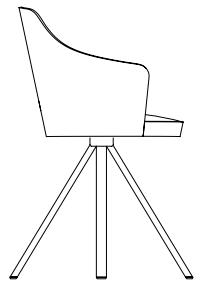

Kaiak Chair Spin Wood

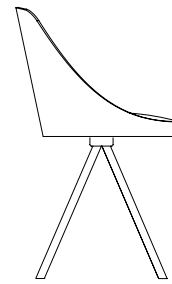

Kaiak Chair Spin Wood with arms

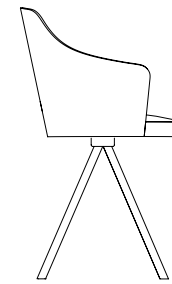

Kaiak Chair 4R Fix & Swivel

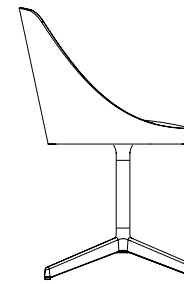

Kaiak Chair 4R Fix & Swivel with arms

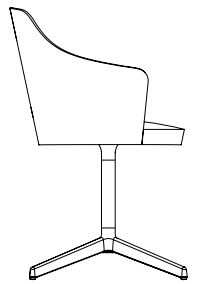

Kaiak Chair 4R with wheels

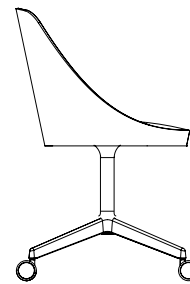

Kaiak Chair 4R with arms and wheels

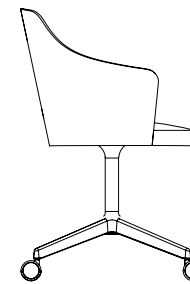

Kaiak Chair 5R

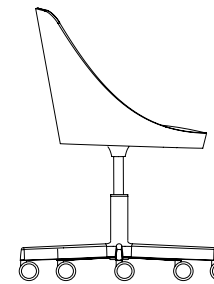

Kaiak Chair 5R with arms

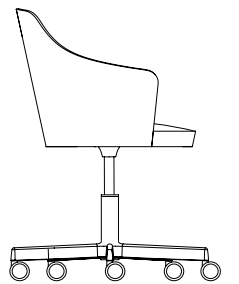

Chair Shells

Wooden shell + upholstered cushion



Upholstered shell 3/4 + upholstered cushion

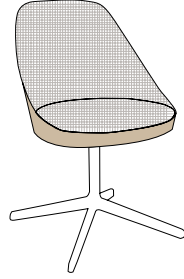

Front upholstered shell + upholstered cushion

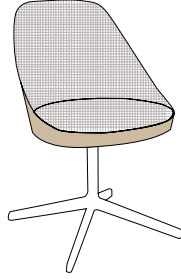

Fully upholstered

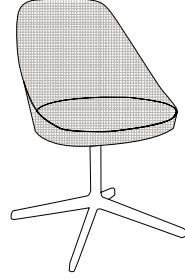

Lounge Chair Shells

Wooden shell + upholstered cushion

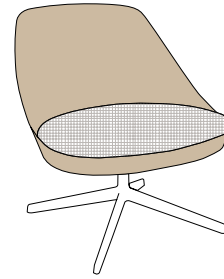

Front upholstered shell + upholstered cushion

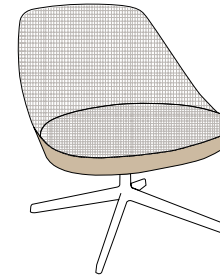

Fully upholstered

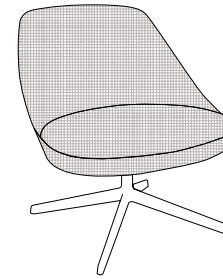

Kaiak Lounge Chairs

Kaiak Lounge Chair Spin Wood

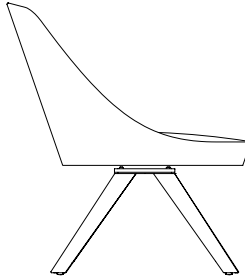

Kaiak Lounge Chair Spin Wood with arms



Kaiak Lounge Chair 4R Fix

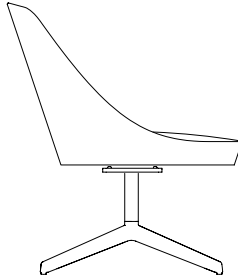

Kaiak Lounge Chair Spin Wood with arms

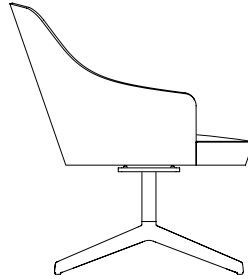

Kaiak Lounge Chair 4R Swivel

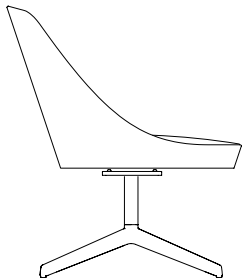

Kaiak Lounge Chair Spin Wood with arms

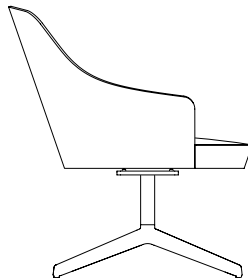

Learn more about the collection
by scanning this QR code.



Street

By Estudi Manel Molina

The chair and stool from the Street collection stand out for their innovative and contemporary design. The innovations in materials which are extremely durable yet minimalist and delicate, are combined with a casual and contemporary design to create a functional collection that's resistant to any climatic conditions. Because the life that inspires us is often outdoors.

La silla y el taburete de la colección Street destacan por su diseño innovador y contemporáneo. Las innovaciones en materiales, extremadamente resistentes y a la vez minimalistas y delicados, se combinan con un estilo desenfadado para crear una colección tan funcional como resistente ante cualquier condición climática. Porque, a menudo, la vida que nos inspira se encuentra al aire libre.

Street 4L





Street 4L chair with arms in White RAL 9016.
Pile table bases h73cm in White RAL 9016 with HPL rounded-square table top in white.



Street



Street 4L Stool

Street 4L stool in Sky Pantone 5435.
Pile table bases h110cm in White RAL 9016 with HPL rounded table top in white.



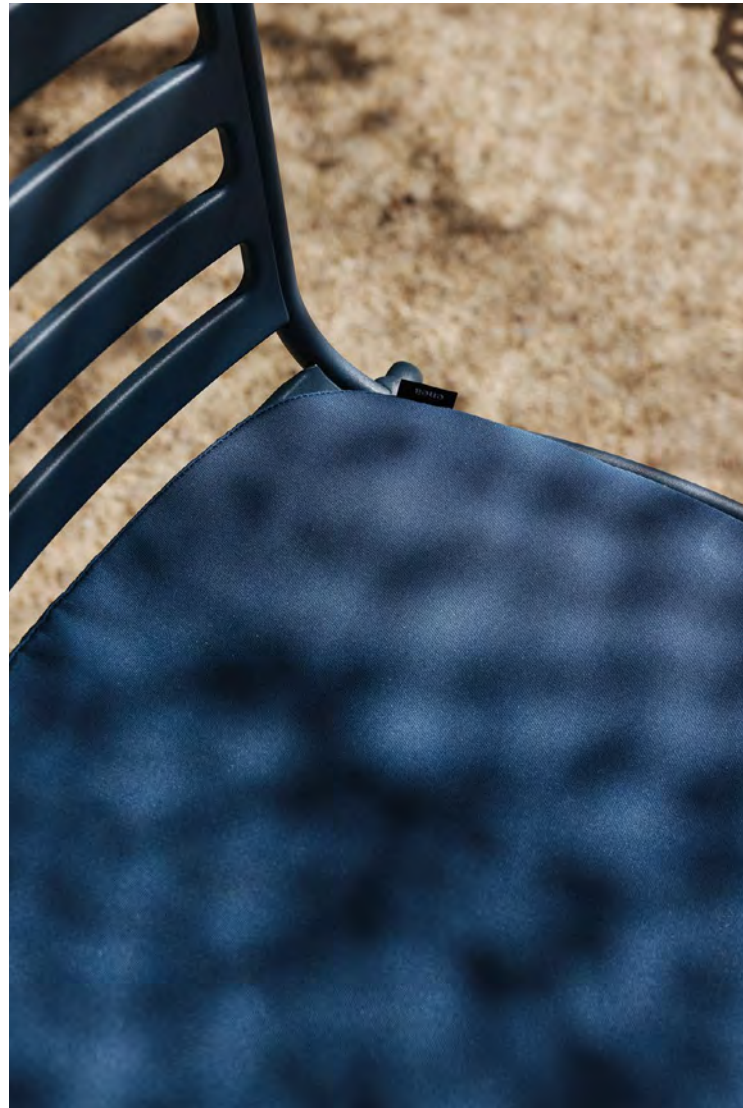

Street 4L stool in Sky Pantone 5435. Street 4L chair in Sand RAL 7032.
Pile table bases h110cm in White RAL 9016 with HPL rounded table top in white.



Street Chairs

Street Chair 4L

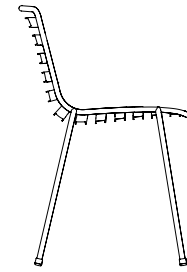

Street Chair 4L with arms

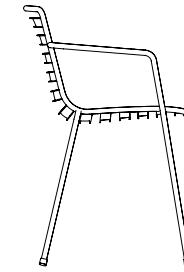

Street Stool

Street Stool 4L Medium & High

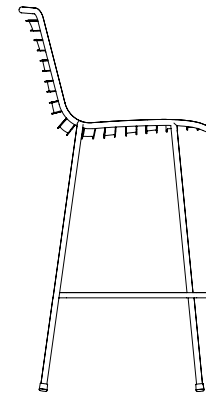

Learn more about the collection
by scanning this QR code.



Caddy

By Estudi Manel Molina

Our Caddy hanging system demonstrates that auxiliary furniture can also be the centre of attention and a statement of style in itself. Either as a wall-based coat hook or a traditional floor-based coat stand, the Caddy collection stands out for its elegance and minimalism, adding a touch of quirkiness to all types of environments.

Nuestra colección de percheros Caddy demuestra que los muebles auxiliares también pueden ser el centro de atención y una declaración de estilo en sí mismos.

Ya sea en su versión de pared o en la tradicional versión de pie, los percheros de la colección Caddy destacan por su elegancia y minimalismo, añadiendo un toque desenfadado a cualquier ambiente.

Caddy Coat Stand





Caddy coat stand 8 hooks in White RAL 9016 and hooks in White PP003.



Caddy coat stand 6 hooks in Sand RAL 7032 and hooks in natural beech MA445.

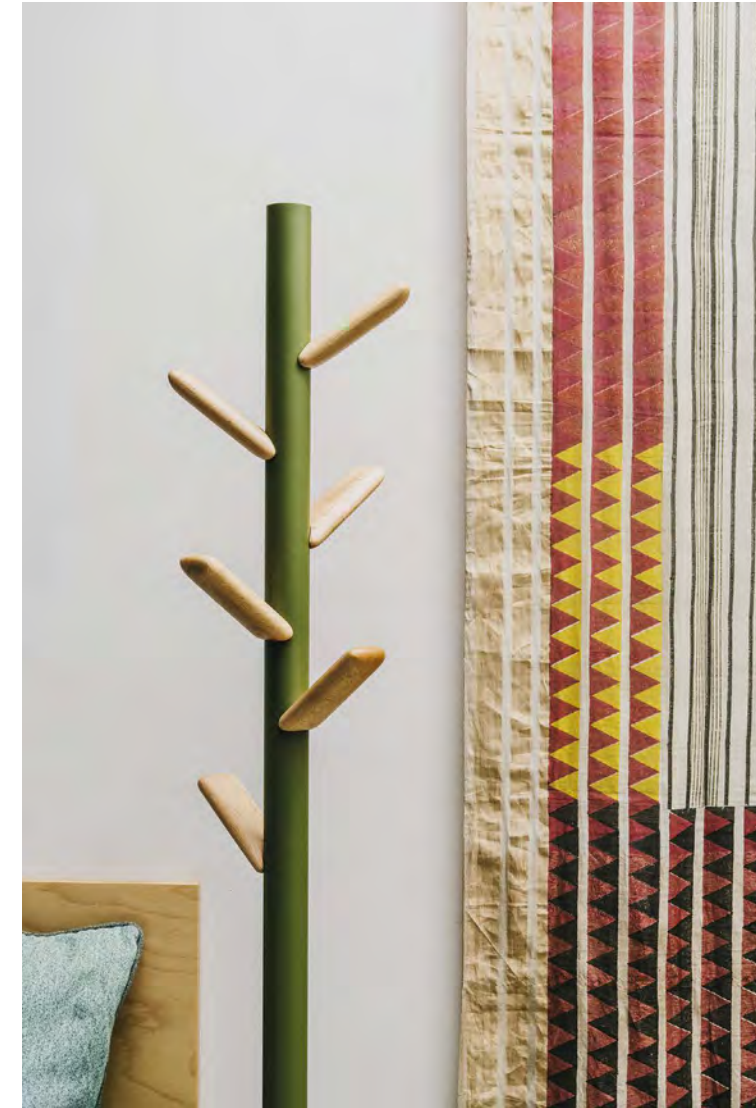

Caddy coat stand 6 hooks in Olive Pantone 5753 and hooks in natural beech MA445. Lottus Sledge chair in Black RAL 9005 with polypropylene shell in White PP003. Lottus Spin chair in Black RAL 9005 with polypropylene shell in Olive PP033.



Caddy Coat Stands

Caddy Coat Stand 6 hooks

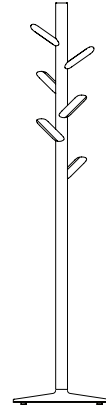

Caddy Coat Stand 8 hooks

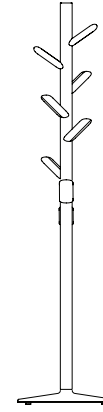

Caddy Coat Stand Wall

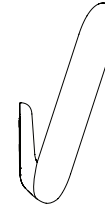

Learn more about the collection
by scanning this QR code.



LTS

By Estudi Manel Molina

The combination of different heights, sizes and finishes, and the endless configurations and accessories available, make our LTS system a comprehensive table programme, offering solutions for both working and residential environments. This is a table “Inspired by life, made by Enea”.

La combinación de distintas alturas, tamaños y acabados, y el sinfín de configuraciones y accesorios disponibles, hacen que la colección LTS se convierta en un completo programa de mesas.

De esta forma, el modelo ofrece soluciones para cualquier entorno, tanto de trabajo como residencial.

Una mesa muy “Inspired by life, made by Enea”.

LTS Table Bases







LTS rounded-square table bases h110cm in natural oak with rounded-square oak table top.
Coma Spin stool high in White RAL 9016 with wooden seat.

LTS rectangular table bases in Black RAL 9005 with HPL rectangular table top in black.
Leku 4L chair in Ocean Pantone 7545 and polypropylene shell in Sky PP032.



LTS



LTS rounded-square table bases h73cm natural oak with rounded-square HPL table top in white.
Lottus Spin chair with aluminum and wing arms in Gloss Black RAL 9005 with fully upholstered shells in Advantage AD055
& Lottus Spin chair in Mustard Pantone 1245 with a fully upholstered shell in Blazer CU22W.





LTS rounded table bases h37cm in natural oak with HPL rounded table top in white.
Lottus 4R lounge in Mustard Pantone 1245 with a fully upholstered shell in Plus FR PLA072.





LTS rounded table bases h73cm in natural oak with LTS rounded oak table top.
Conference 4R chair with arms in Wine Pantone 4975 and a fully upholstered shell in Valencia Rot 107-2075.

LTS rounded-square table bases h73cm in natural oak with LTS rounded-square oak table top.
Noa 4L Wood chair with a fully upholstered shell in Seattle ES047.



LTS Table Bases

LTS Table Bases Round

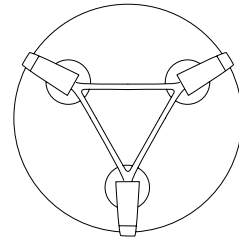

LTS Table Bases Rounded-square

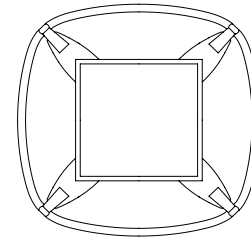

LTS Table Bases Square

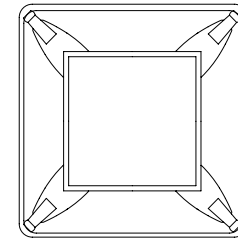

LTS Table Bases Rectangular

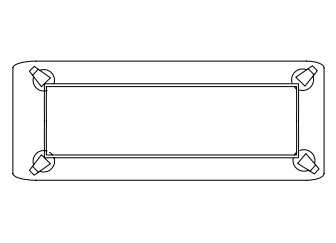

LTS Table Bases Wing

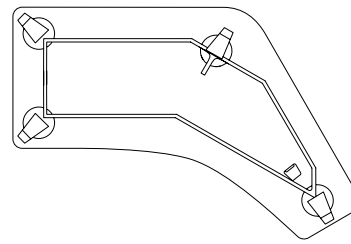

LTS Table Tops

LTS Table Top Round

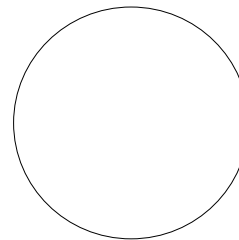

LTS Table Top Rounded-square

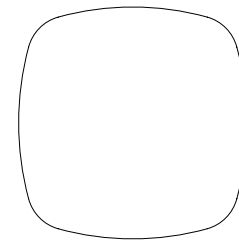

LTS Table Top Square

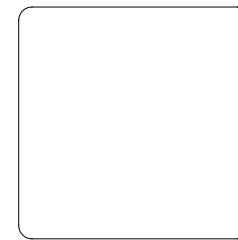

LTS Table Top Rectangular

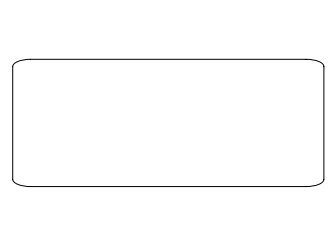

LTS Table Top Wing

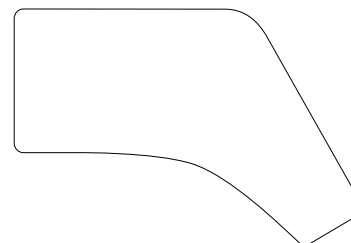

Learn more about the collection
by scanning this QR code.



Ema

By Lievore Altherr Molina

Hard-wearing, lightweight, and with perfect stacking capacity, the Ema chair represents the transformation of a classic piece through an innovative combination of engineering and design. Thanks to advanced technologies, Ema is extremely functional, becoming a great ally for the creation of adaptable, durable, and really stylish spaces.

Resistente, ligera y con capacidad de apilamiento perfecta, la silla Ema revoluciona un diseño clásico mediante una combinación innovadora de ingeniería y diseño. Gracias a tecnologías avanzadas, Ema resulta extremadamente funcional y se convierte en una gran aliada para crear espacios adaptables, duraderos y con mucho estilo.

Ema 4L

Ema 4L chair with arms in Navy Blue Pantone 533 with upholstered shell and pad in Fame 60017.





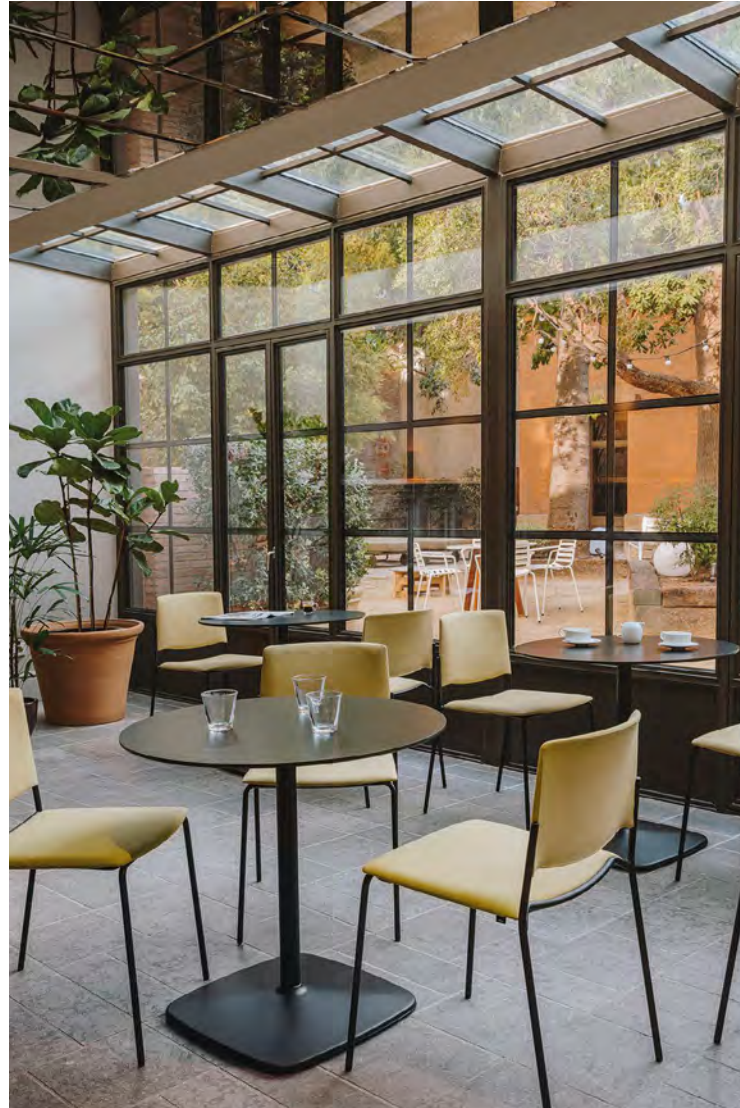

Ema 4L chair in Black RAL 9005 with a fully upholstered shell in Canvas 446.
Iron rounded-square table bases h73cm in Black RAL 9005 with HPL table top in black.

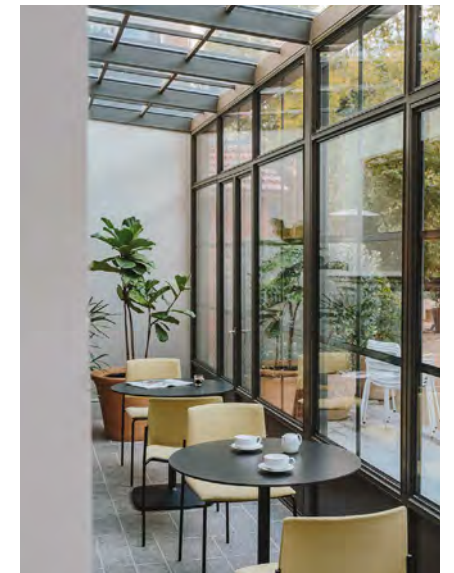

Ema Sledge





Cappuccino 3.25
Con patina 2.75
cafe mokah 2.25
macchiato 3.00

CAFE	
SOLO 1.6	
CORTADO 1.7	H2O 1.2
FLAT WHITE 2.2	
AMERICANO 1.7	CON AVENA 2.3
VEO POUR OVER (FILTRO) 3	

TE		INFUSIONES	
EARL GREY 2		ROOIBOS 2-2	
POWDER		MANZANILLA	
ENGLISH BREAKFAST		POLEONENYA	
MON JEN JIBRE			
& ECHINACEA 2-2			

DESAYUNOS
HOFMANN PASTELERIA
TOSTADAS ECO

Ema Sledge chair chromed with polypropylene shell in White PP003. Ema Sledge chair in Black RAL 9005 with polypropylene shell in White PP003. Ema Sledge chair with arms in Black RAL 9005 with polypropylene shell in Black PP400.

Ema Sledge chair with arms in Black RAL 9005 and a fully upholstered high shell in Plus FR PLA108.



Ema Sledge Stool

Ema Sledge stool chromed with polypropylene shell in White PP003. Ema Sledge stool in White RAL 9016 with polypropylene shell in White PP003.



Ema Sledge stool in Gloss Black RAL 9005 with polypropylene shell in Black PP400.
Lottus AL table bases h110cm in White RAL 9016 with HPL table top in black.



Emma Chairs

Emma Chair 4L

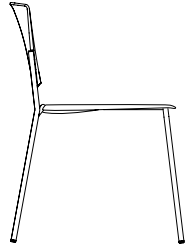

Emma Chair 4L with arms

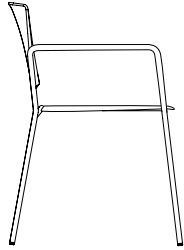

Emma Chair Sledge



Emma Chair Sledge with arms

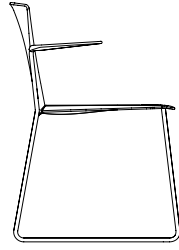

Chair Shells

Polypropylene shell + seat

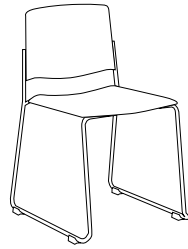

Polypropylene shell high + polypropylene seat

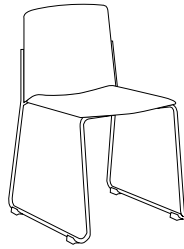

Polypropylene shell + upholstered pad

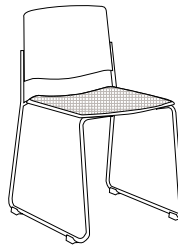

Polypropylene shell high + upholstered pad

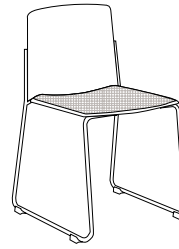

Polypropylene shell + upholstered seat

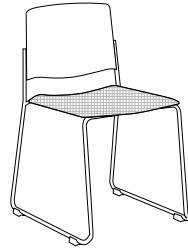

Polypropylene shell high + upholstered seat

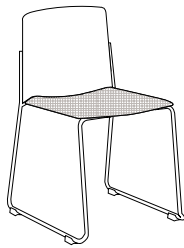

Upholstered shell + upholstered pad

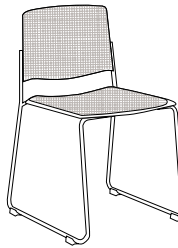

Upholstered shell high + upholstered pad

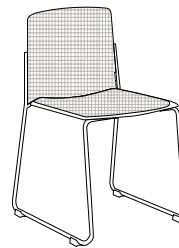

Fully upholstered

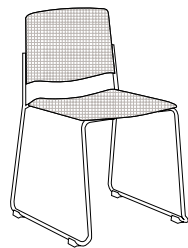

Fully upholstered high

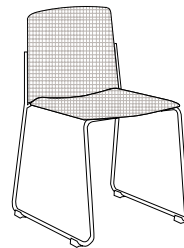

Emma Stools

Emma Stool Sledge Medium & High

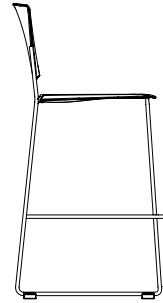

Stool Shells

Polypropylene shell + seat

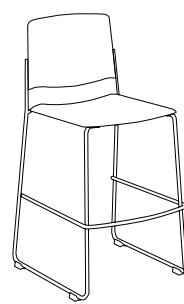

Polypropylene shell high + polypropylene seat

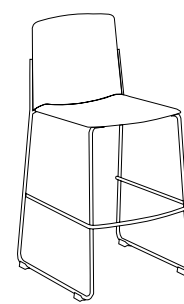

Polypropylene shell + upholstered pad

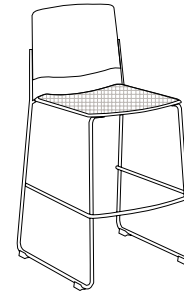

Polypropylene shell high + upholstered pad

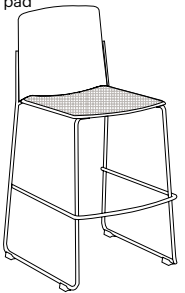

Polypropylene shell + upholstered seat

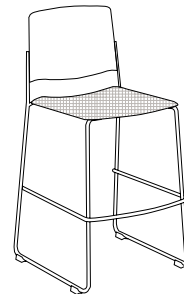

Polypropylene shell high + upholstered seat

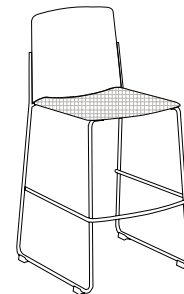

Upholstered shell + upholstered pad

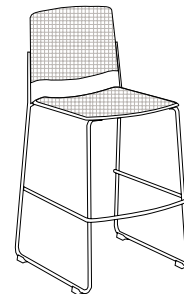

Upholstered shell high + upholstered pad

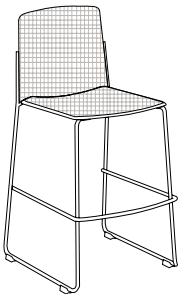

Fully upholstered

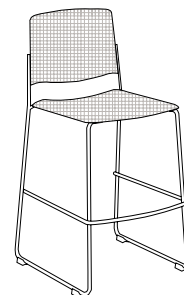

Fully upholstered high

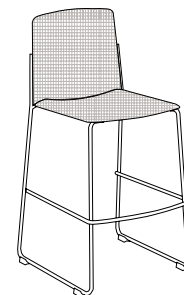

Learn more about the collection
by scanning this QR code.



Way

By Llusà Design

Our Way modular table system is minimalist yet highly functional. A simple assembly system with a wide range of available accessories make this a flexible and attractive piece for professional and commercial utility sectors. Ideal to meet the needs of a work environment but also to be explored in other types of spaces.

El sistema de mesas modular Way es minimalista pero altamente funcional. Un sistema de montaje aparentemente simple y la amplia gama de accesorios hacen que sea una pieza flexible y atractiva de mobiliario profesional y comercial utilitario. Perfecta para cubrir las necesidades propias de un entorno laboral pero también para explorar en otro tipo de espacios.

Way Table Bases





Way table bases h75cm in Teja Pantone 174 with HPL oak table top. Leku 4L chair in Teja Pantone 174 with polypropylene shell in Teja PP036.



Way





Way Table Bases

Way Table Bases Rectangular

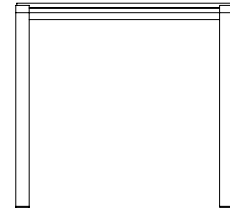

Way Table Bases Left Wing

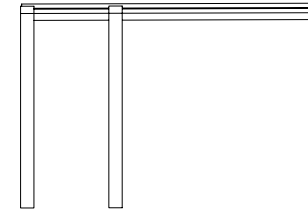

Way Table Bases Right Wing

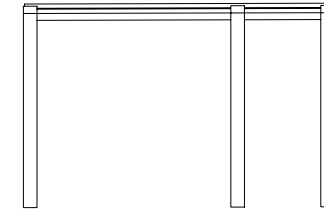

Way Table Tops

Way Table Top Rectangular



Way Table Top Left Wing

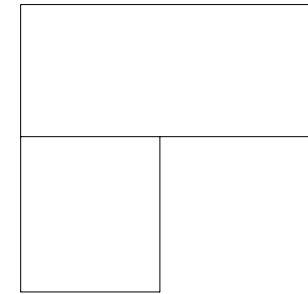

Way Table Top Right Wing

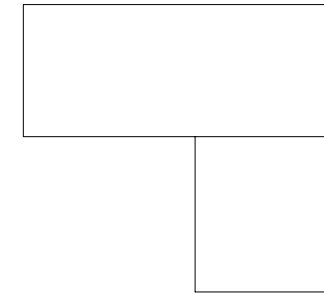

Learn more about the collection
by scanning this QR code.



Folio

By Llusca Design

The Folio table has been designed for flexible and dynamic environments. Its folding mechanism and castors facilitate stacking and storage without sacrificing on looks. In addition to a variety of accessories, Folio features a metal frame and a melamine tabletop available in different sizes.

La mesa Folio ha sido diseñada para entornos flexibles y dinámicos, ya que su sistema de plegado y sus ruedas permiten el apilado y el almacenaje sin renunciar a la estética. Cuenta con una encimera de melamina de diferentes tamaños y con una estructura de metal, además de una gran variedad de accesorios.

Folio Table

Folio table h74cm in White RAL 9016 with Melamine rectangular table top in white.



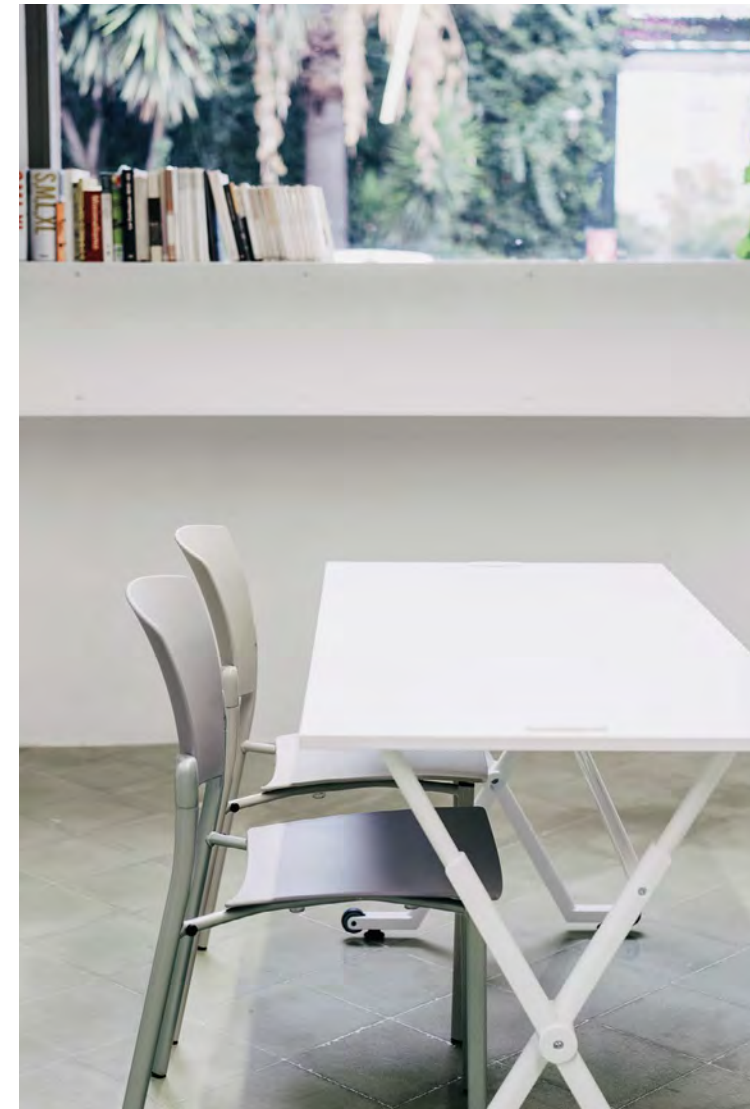

Folio table h74cm in Gloss White RAL 9016 with Melamine rectangular table top in white.
Eina 4L chair in White RAL 9016 with polypropylene shell and seat in White PP003.
Eina 4L chair in Grey RAL 7004 with polypropylene shell and seat in Black PP400.

Folio table h74cm in Olive Pantone 5753 with Melamine rectangular table top in white.





Folio table h74cm in White RAL 9016 with Melamine rectangular table top in white.
Movado 5R chair with arms chromed and a fully upholstered shell in Blazer CUZ1J.

Folio Table

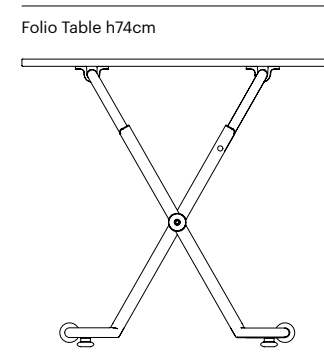

Learn more about the collection
by scanning this QR code.



Lottus

By Lievore Altherr Molina

Our Lottus collection is inspired by nature and is synonymous with versatility. With its wide range of materials and finishes, Lottus offers infinite configurations for your space. The furniture included in this collection have been designed to provide comfort and elegance to any environment combining great aesthetics and functionality.

La colección Lottus, inspirada en la naturaleza, es sinónimo de versatilidad. Con una amplia variedad de materiales y acabados, Lottus ofrece infinitas posibilidades para tu espacio. Los asientos y mesas de la colección, diseñados para brindar comodidad y elegancia a cualquier entorno, combinan estética y funcionalidad.

Lottus 4L





Lottus Sledge





Lottus Sledge chair in Gloss Black RAL 9005 with polypropylene shell in Black PP400.



Lottus Spin

Lottus Spin chair with aluminum arms in Gloss Black RAL 9005 with a fully upholstered shell in Advantage AD055 Black & Lottus Spin chair in Mustard Pantone 1245 with a fully upholstered shell in Blazer CU22W.



Lottus 4R

Lottus 4R chairs with wheels in Black RAL 9005 with fully upholstered shells in Valencia Schwarz 9035 & Terracotta 0035. LTS rounded-square table bases h73cm in natural oak with rounded-square oak table top.



Lottus 4R chair in Black RAL 9005 with polypropylene shell in Black PP400.



Lottus



Lottus 4R chair with aluminum arms in Black RAL 9005 and a fully upholstered shell in Blazer CUZ2Q.

Lottus Spin Wood





Lottus 5R

Lottus 5R chair in Black RAL 9005 with polypropylene shell in Black PP400 and upholstered pad in Paris EP012.
Lottus 5R chair in Black RAL 9005 with a fully upholstered shell in Paris EP001. LTS wing table bases h73cm in natural oak with HPL wing table top in black.





Lottus 5R chair in Gloss Black RAL 9005 with polypropylene shell in Grey PP017.



Lottus Tray





Lottus Tray chair in White RAL 9016 with polypropylene shell in White PPO03 and pad upholstered in Main Line Flax MLF26.

Lottus 4L Wood Stool

Lottus 4L Wood stool in natural birch with birch shell
& Lottus 4L Wood stool in natural birch with polypropylene shell in White PP003.





Lottus 4L Wood stool in natural birch with a fully upholstered shell in Canvas 2 644.



Lottus Sledge Stool



Lottus Central Column Stool



Lottus Spin Stool

Lottus Spin stool in Ocean Pantone 7545 with a fully upholstered shell in Plus FR PLA082.



Lottus Central Column stool in Olive Pantone 5753 with polypropylene shell and pad in Olive PP033
& Lottus Spin stool in White RAL 9016 with polypropylene shell in White PP003.



Lottus Spin Wood Stool





Lottus 4L Wood Lounge



Lottus 4R Lounge



Enea



Lottus 4R lounge in Black RAL 9005 with a fully upholstered shell in Valencia Terracotta 107-0035 & Lottus 4R lounge in Black RAL 9005 with a fully upholstered shell in Valencia Melone 107-6013. LTS rectangular table bases h37cm in natural oak with HPL rectangular table top in white.

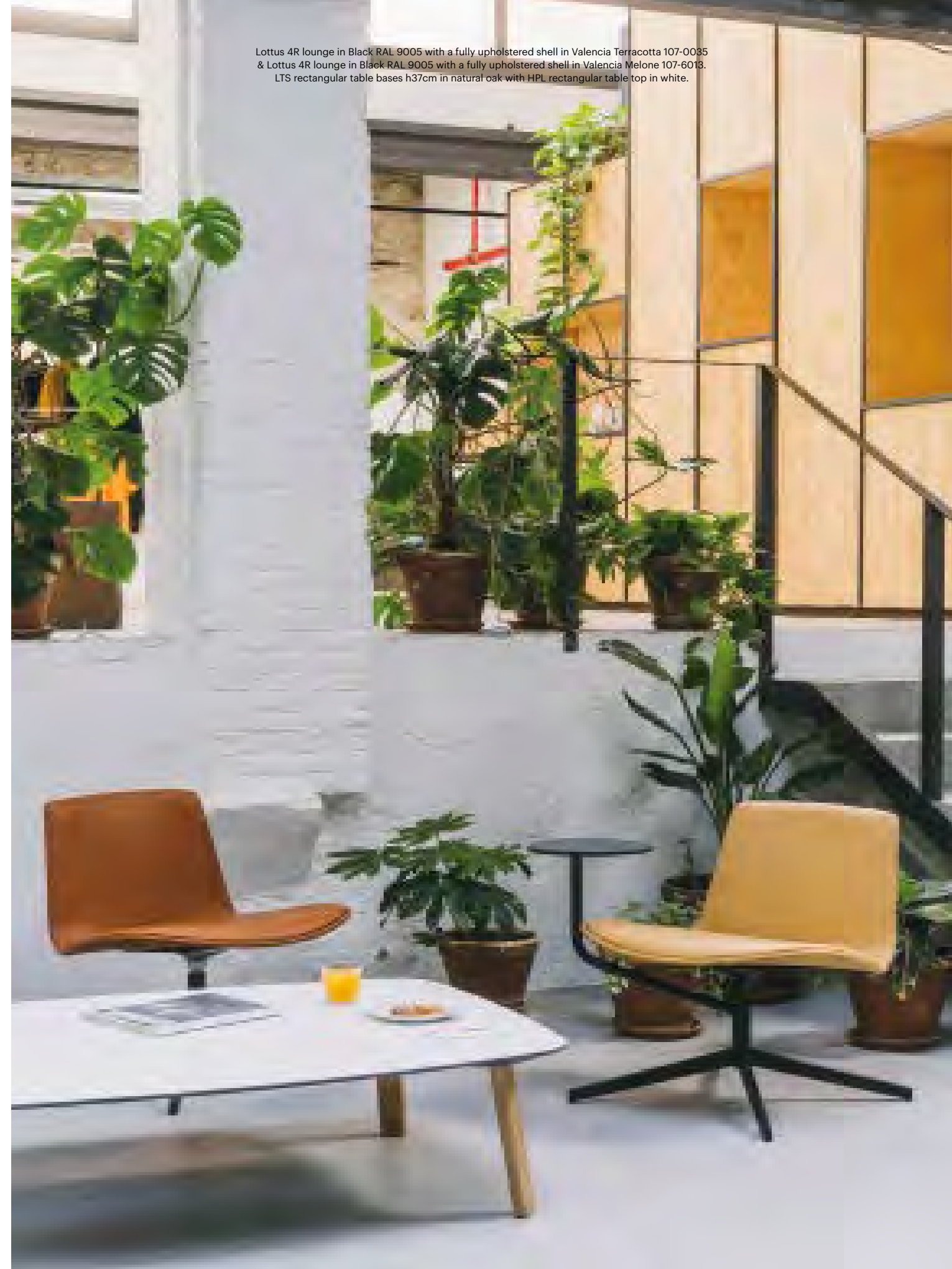

Lottus Sledge Lounge

Lottus Sledge lounge in Mustard Pantone 1245 with a fully upholstered shell in Plus FR PLA072.
Taber rounded side table h37cm in Grey RAL 7004 with oak rounded table top.



Lottus Ottoman



Lottus Table Bases





Lottus Modular Benches



Lottus Chairs

Lottus Chair 4L

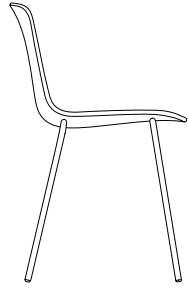

Lottus Chair 4L with steel arms

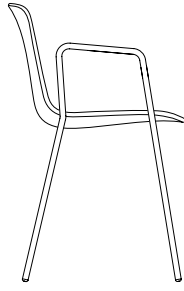

Lottus Chair 4L with aluminium arms

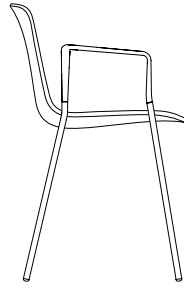

Lottus Chair 4L with wing arms

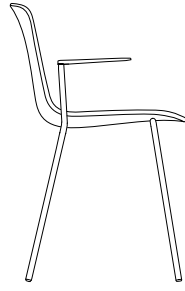

Lottus Chair Sledge

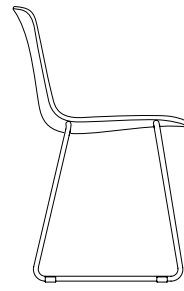

Lottus Chair Sledge with arms

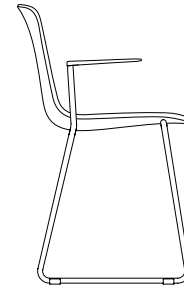

Lottus Chair Spin Fix & Swivel

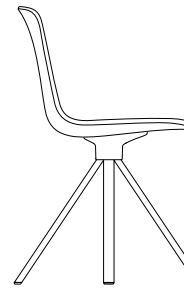

Lottus Chair Spin Fix & Swivel with wing arms

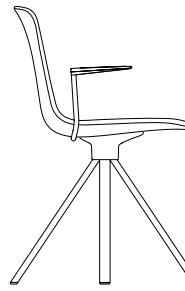

Lottus Chair 4L with wheels

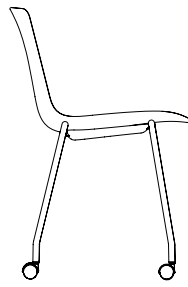

Lottus Chair 4L Wood

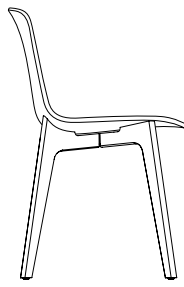

Lottus Chair 4L Wood with wood arms

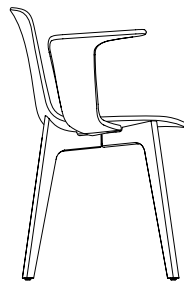

Lottus Chair 4R Fix & Swivel

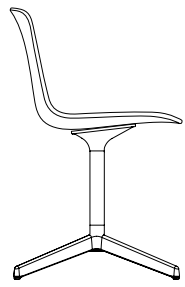

Lottus Chair Spin Fix & Swivel with aluminium arms

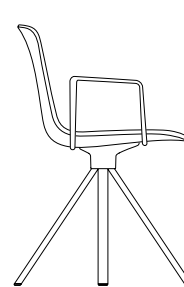

Lottus Chair Spin Fix & Swivel with wood arms



Lottus Chair Spin Wood

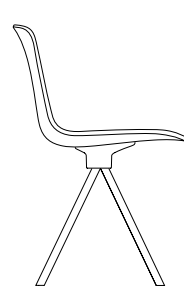

Lottus Chair Spin with wood arms

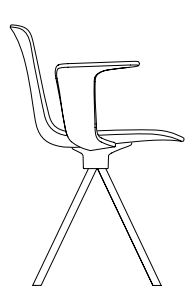

Lottus Chair 4R Fix & Swivel with aluminium arms

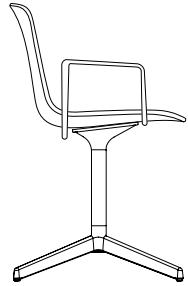

Lottus Chair 4R Fix & Swivel with wood arms

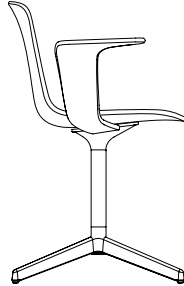

Lottus Chair 4R Fix with wheels

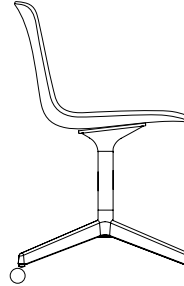

Lottus Chair 4R with wheels and aluminium arms

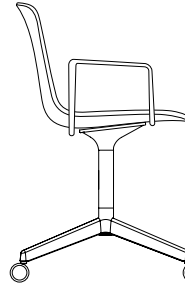

Lottus Chair Tray

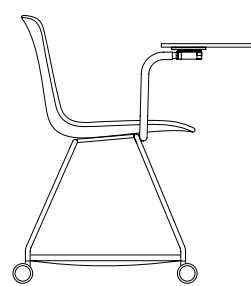

Lottus Chair 4R Fix with wheels and wood arms

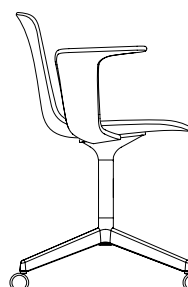

Lottus Chair 5R

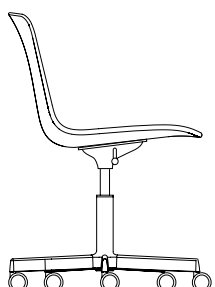

Lottus Chair 5R with aluminium arms

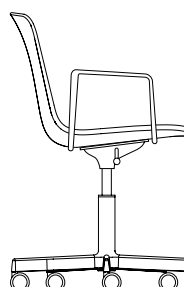

Lottus Chair 5R with wood arms

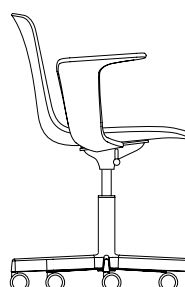

Chairs Shells

Polypropylene shell

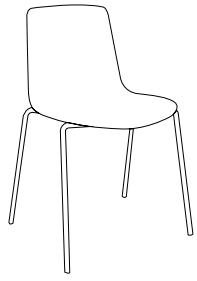

Polypropylene high shell

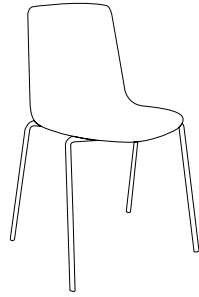

Polypropylene shell + pad

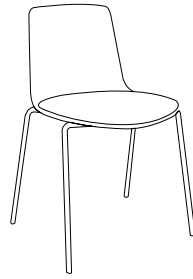

Polypropylene shell + upholstered pad



Polypropylene high shell + pad



Polypropylene high shell + upholstered pad

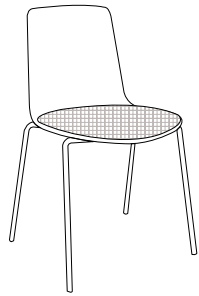

Polypropylene high shell + partial upholstery

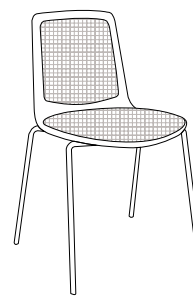

Oak or birch wood shell

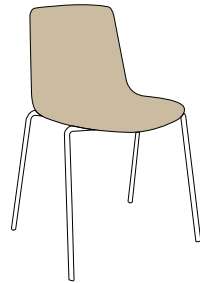

Oak or birch shell + upholstered seat pad

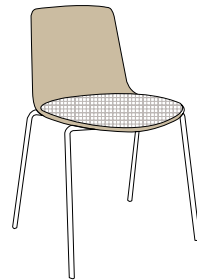

Oak or birch shell + front upholstery

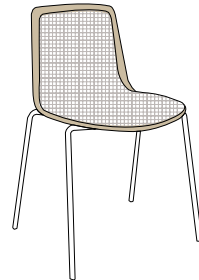

Fully upholstered

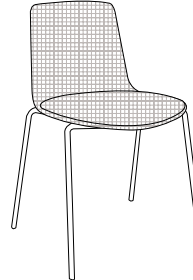

Fully upholstered high shell

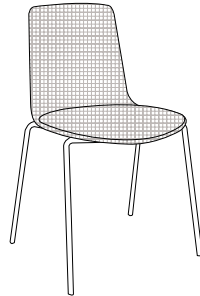

Fully upholstered triple foam high shell

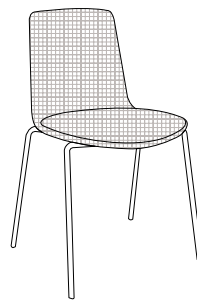

Lottus Stools

Lottus Stool High Sledge Stackable

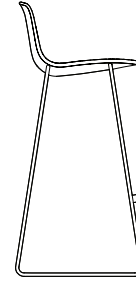

Lottus Stool Sledge Medium & High

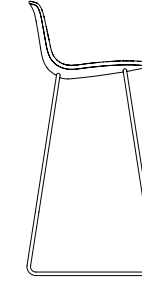

Lottus Stool Spin Medium & High

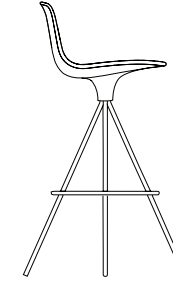

Lottus Stool Central Column Medium & High

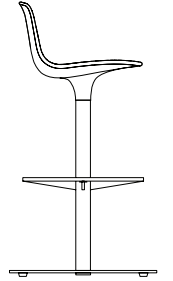

Lottus Stool Spin Wood Medium & High

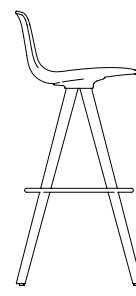

Lottus Stool 4L Wood Medium & High

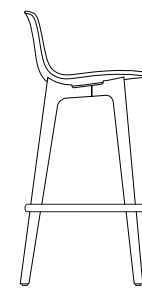

Stool Shells

Polypropylene shell

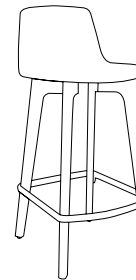

Polypropylene shell + pad

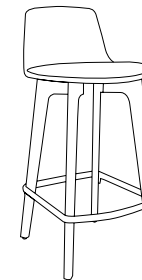

Polypropylene shell + upholstered pad



Oak or birch wood shell

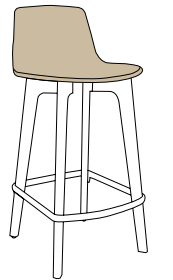

Oak or birch shell + upholstered seat pad

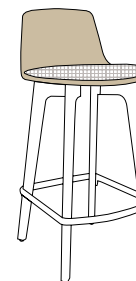

Oak or birch shell + front upholstery

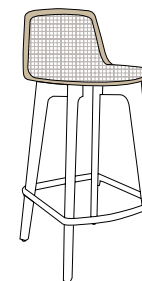

Fully upholstered

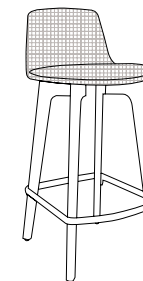

Lottus Lounge Chairs

Lottus Lounge Chair Sledge

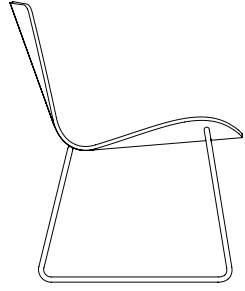

Lottus Lounge Chair 4L Wood

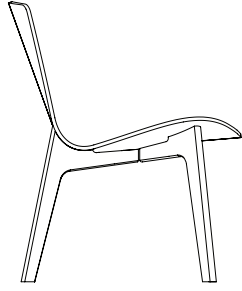

Lottus Lounge Chair 4R Fix & Swivel

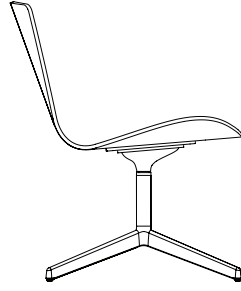

Lottus Lounge Chair 4R Fix & Swivel with aluminium arms



Lottus Lounge Chair 4R Fix & Swivel with wood arms



Ottoman Lottus 4R

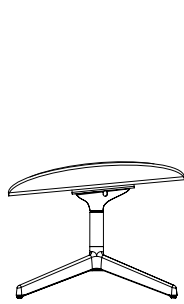

Lounge Chair Shells

Oak or birch wood shell



Oak or birch shell + upholstered seat pad



Oak or birch shell + front upholstery

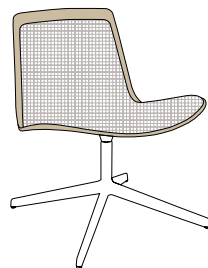

Fully upholstered

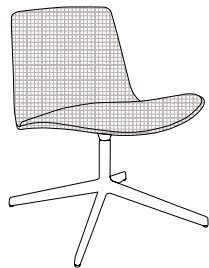

Fully upholstered high version

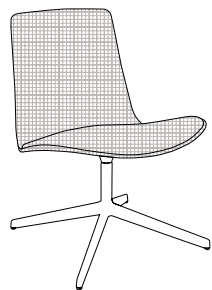

Fully upholstered

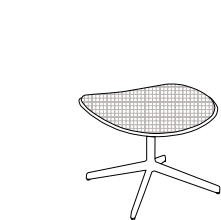

Lottus Modular Benches

Lottus Modular benches 2 places

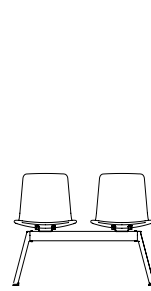

Lottus Modular benches 2 places with arms

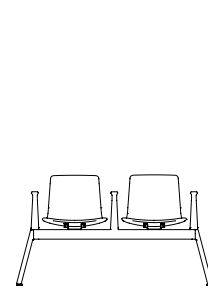

Lottus Modular benches 2 places with side arms

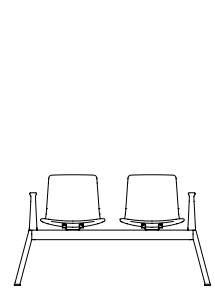

Lottus Modular benches 3 places

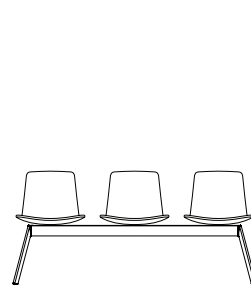

Lottus Modular benches 3 places with arms

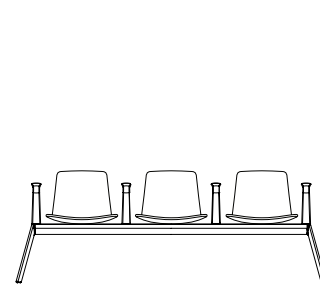

Lottus Modular benches 3 places with side arms

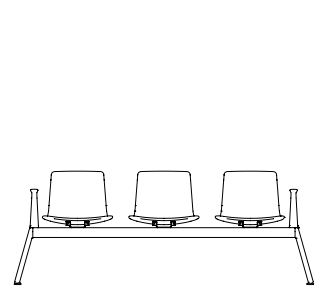

Lottus Modular benches 4 places

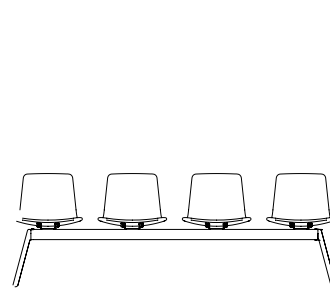

Lottus Modular benches 4 places with arms

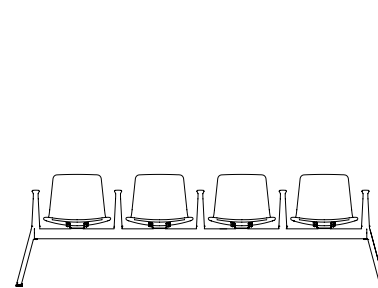

Lottus Modular benches 4 places with side arms

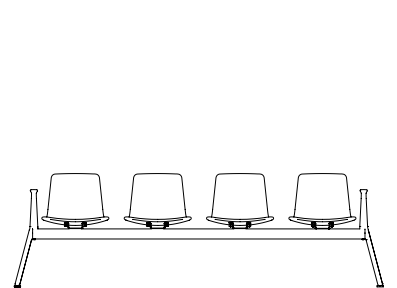

Lottus Modular benches 5 places

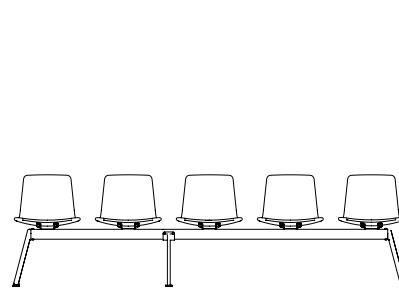

Lottus Modular benches 5 places with arms

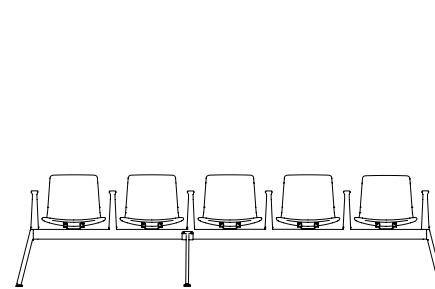

Lottus Modular benches 5 places with side arms

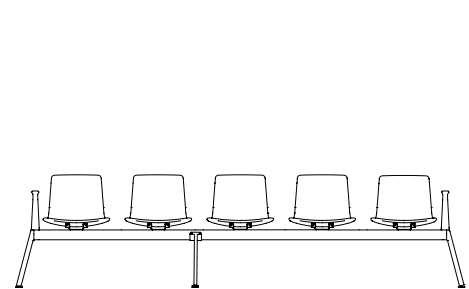

Modular Benches Shells

Polypropylene shell Polypropylene high shell Polypropylene shell + pad Polypropylene shell + upholstered pad



Polypropylene high shell + pad Polypropylene high shell + upholstered pad Polypropylene high shell + partial upholstery Oak or birch wood shell

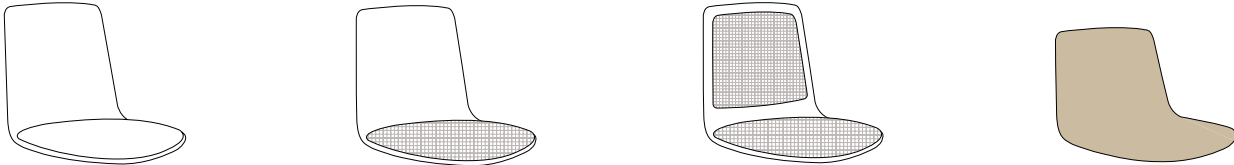

Oak or birch shell + upholstered seat pad Oak or birch shell + front upholstery Fully upholstered shell Fully upholstered high shell



Fully upholstered triple foam high shell

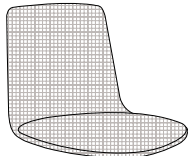

Lottus Table Bases

Lottus Table Bases rounded-square

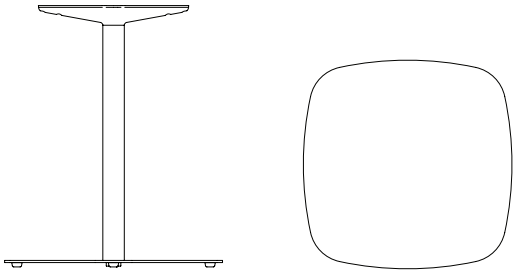

Learn more about the collection by scanning this QR code.



Lottus Kids

By Lievore Altherr Molina

With Lottus Kids, we have fused innovation with comfort to offer an outstanding collection of chairs especially designed for children. Our wide range of sizes and colours lets you create fun and vibrant environments that are strong and durable at the same time.

Con Lottus Kids, hemos fusionado la innovación con la comodidad para ofrecer una excepcional colección de sillas diseñadas especialmente para los más pequeños. Nuestra variedad de tamaños y una amplia paleta de colores permiten crear ambientes divertidos y vibrantes, así como fuertes y duraderos.

Lottus Kids 4L





Lottus Kids Chairs

Lottus Kids Chair 4L h30cm, h34cm & h38cm

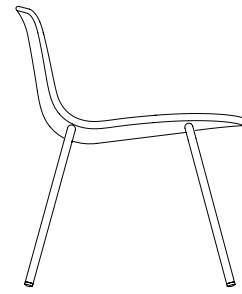

Lottus Kids Chair Shells

Polypropylene shell

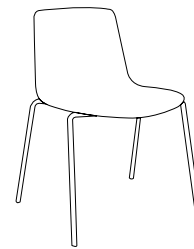

Polypropylene shell + pad



Polypropylene shell + upholstered pad

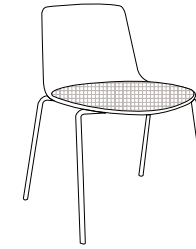

Learn more about the collection
by scanning this QR code.



Lottus AL

By Lievore Altherr Molina

Our Lottus AL table is available in three different heights, and features a 4-star aluminium base that can be either polished or lacquered in any of our colours. Tabletops are available with different finishes and in various shapes and sizes. This is the perfect piece for cafés, bars, restaurants and hotels, and can also perfectly suit corporate environments.

Disponibile en tres alturas, la mesa Lottus AL cuenta con una base de 4 radios de aluminio pulida o lacada en cualquiera de nuestros colores. Las encimeras pueden llevar diferentes acabados, tamaños y formas, por lo que es perfecta para cafeterías, bares, restaurantes y hoteles, aunque también es adecuada para entornos más corporativos.

Lottus AL Table Bases





Lottus AL table bases h72cm in White RAL 9016 with HPL rounded-square table top in white.
Lottus 4L chair with aluminium arms in Teja Pantone 174 with polypropylene high shell in Teja PPO36 and upholstered pad in Valencia Nectarine 107-6003.



Lottus AL Table Bases

Lottus AL Table Bases 4R Ø85cm

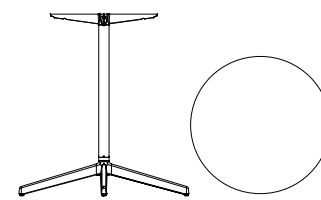

Enea Medium Table Top

Enea Medium Table Top Square



Enea Medium Table Top Rounded-square

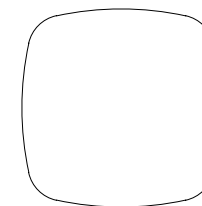

Enea Medium Table Top Round

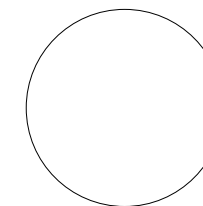

Learn more about the collection
by scanning this QR code.



Conference

By Lievore Altherr Molina

The chairs from the Conference collection combine professionalism, style, and comfort. Their sleek and minimalist design is based on adaptable cutting-edge technology for optimal comfort and performance. This is the perfect solution for meeting rooms and conference halls.

If you really need to get together and share, then it's best to do so in an inspiring environment.

Las sillas de la colección Conference combinan profesionalidad, estilo y comodidad. Su diseño minimalista y elegante se basa en una tecnología de vanguardia adaptable para un confort y unas prestaciones óptimas. Una solución perfecta para salas de reuniones y conferencias. Porque si tienes que reunirte y compartir, que sea en un entorno inspirador.

Conference 4R





Conference 4R chair with arms in Black RAL 9005 with a fully upholstered shell in Advantage AD118.
LTS wing table bases h73cm in natural oak with HPL wing table top in white.



Conference 4R chairs with arms in Wine Pantone 4975 and fully upholstered shells in Valencia Rot 107-2075.
LTS rounded table bases h73cm in natural oak with rounded oak LTS table top.

Conference 5R





Conference Chairs

Conference Chair 4R Fix with wheels



Conference Chair 4R Fix with arms & wheels



Conference Chair 4R Swivel

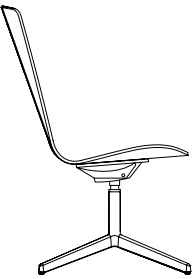

Conference Chair 4R Swivel with arms



Conference Chair 5R

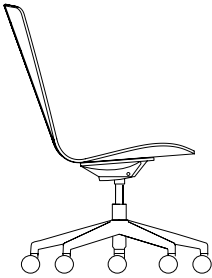

Conference Chair 5R with arms

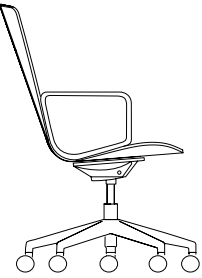

Chair Shells

Wooden shell + upholstered pad



Front upholstery

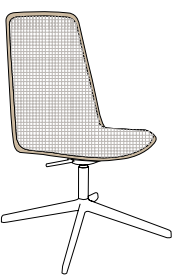

Fully upholstered

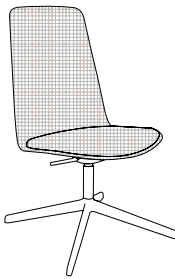

Learn more about the collection by scanning this QR code.



Oh!

By Gabriel Teixidó Sabater

The armchairs of our Oh! collection are sophisticated and welcoming, and easily adapt to any environment. Durability and comfort merge in a collection that combines with your imagination to create functional and highly aesthetic spaces.

Las butacas de la colección Oh! son sofisticadas y acogedoras, y se adaptan con facilidad a cualquier ambiente. Durabilidad y confort se fusionan en una colección que se alía con tu imaginación a la hora de crear espacios funcionales y de estética elevada.

Oh! Sledge Lounge



Oh! 4R Lounge

Oh! 4R lounge in White RAL 9016 with a front upholstered shell and upholstered pad in Fame 64166.





Oh!

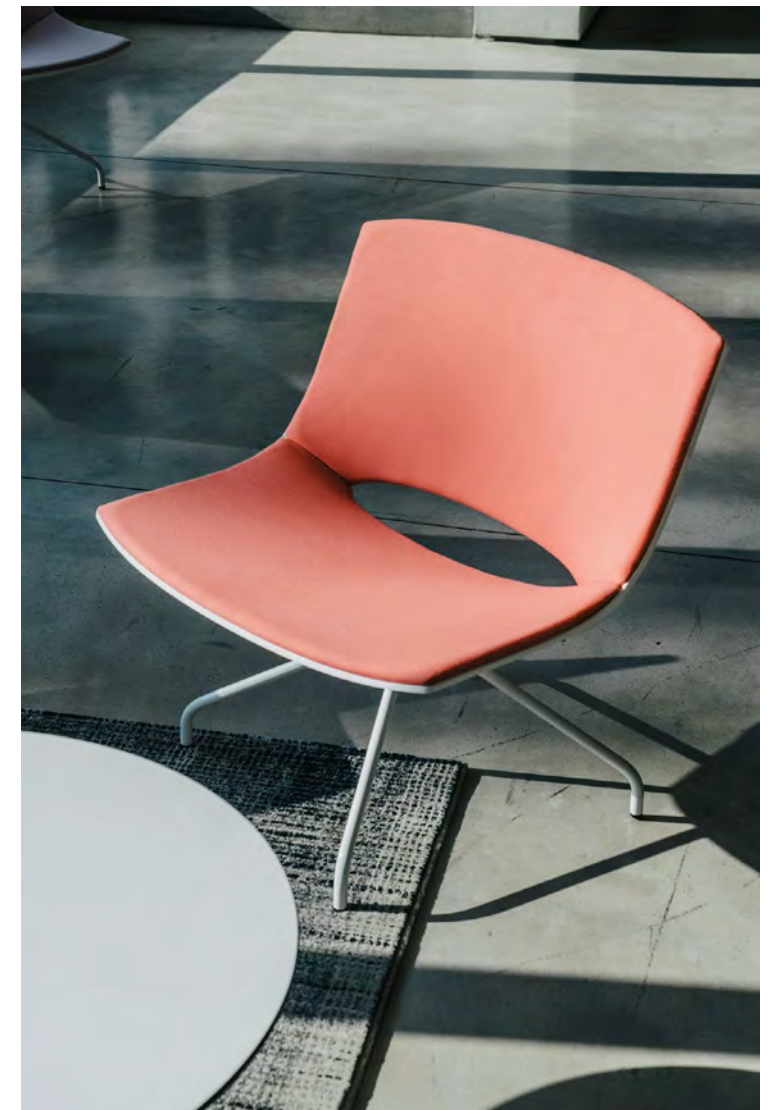

Oh! Sledge Side Table

Oh! Spin side table in White RAL 9016 with HPL rounded table top in white. Oh! Sledge side table in White RAL 9016 with HPL squared table top in white. Oh! 4R lounges in White RAL 9016 with front upholstered shells and upholstered pads in Fame 62068 and Fame 60999. Oh! Sledge lounges in White RAL 9016 with a front upholstered shell and upholstered pad in Fame 62067 and a polypropylene shell in White PP003.



Oh! Spin Side Table





Oh! Lounge Chairs

Oh! 4R Lounge Chair Fix & Swivel



Oh! Lounge Chair Sledge

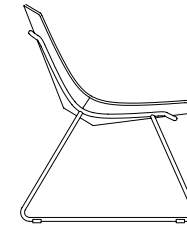

Lounge Chair Shells

Polypropylene shell

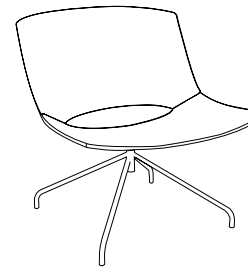

Front upholstered shell + upholstered pad



Oh! Side Tables

Oh! Side Table Spin

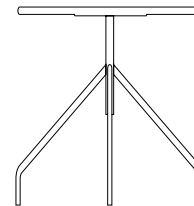

Oh! Side Table Sledge

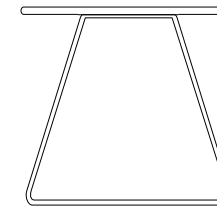

Learn more about the collection
by scanning this QR code.



Bio

By Llusà Design

Bio is a collection designed for both comfort and intensive use within workspaces and the contract sector. It includes two versions: a lighter one with a short backrest, and another more ergonomic version with a tall backrest.

Bio es una colección concebida para el confort y el uso intensivo del sector contract y de los espacios de trabajo. Hay dos versiones disponibles, una más ligera con respaldo corto y otra más ergonómica con respaldo largo.

Bio 4L





Bio 4L chair with arms in Gloss Aluminium RAL 9006 with a fully upholstered shell in Crisp 4034.
Way table bases in White RAL 9016 with HPL table top in white.



Bio



Bio 5R



Bio Modular Benches



Bio Chairs

Bio 4L Chair

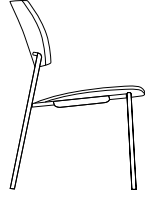

Bio 4L Chair with arms

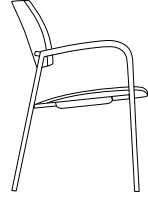

Bio 5R Chair



Bio 5R Chair with arms



Bio Modular Benches

Bio Modular Benches 2 places

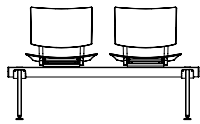

Bio Modular Benches 2 places with arms

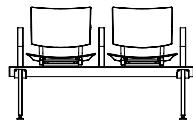

Bio Modular Benches 2 places with side arms

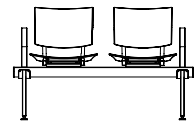

Bio Modular Benches 3 places

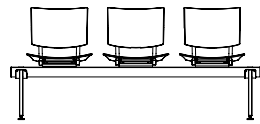

Bio Modular Benches 3 places with arms

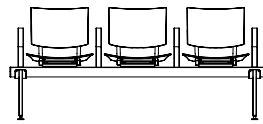

Bio Modular Benches 3 places with side arms

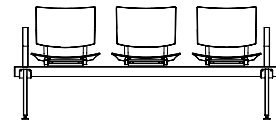

Bio Modular Benches 4 places

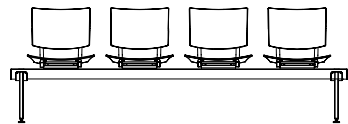

Bio Modular Benches 4 places with arms

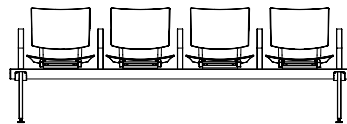

Bio Modular Benches 4 places with side arms

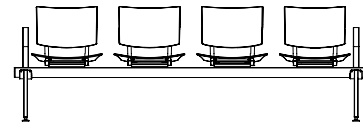

Bio Modular Benches 5 places

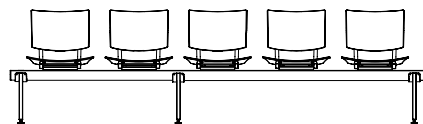

Bio Modular Benches 5 places with arms

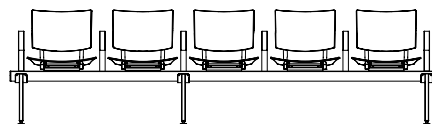

Bio Modular Benches 5 places with side arms

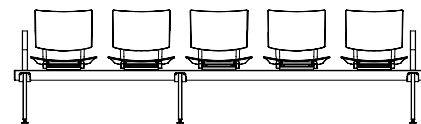

Chair & Modular Benches Shells

Polypropylene backrest + polypropylene seat

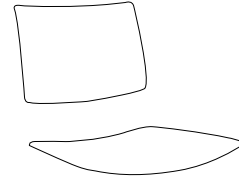

Polypropylene backrest high + polypropylene seat

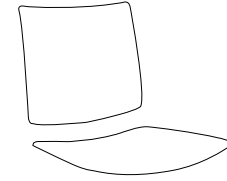

Polypropylene backrest + upholstered seat

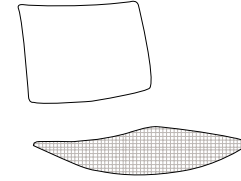

Polypropylene backrest high + Upholstered pad

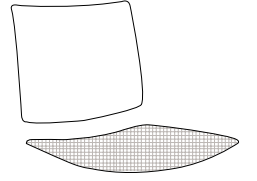

Fully upholstered

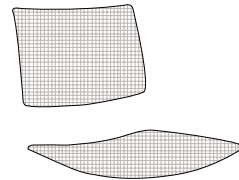

Fully upholstered high

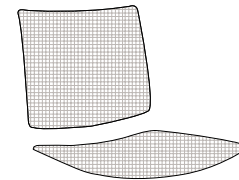

Learn more about the collection
by scanning this QR code.



Coma

By Llusca Design

The stools from the Coma collection are characterised by their lightweight design and wide range of finishes to fit all types of settings and environments. Coma is available in different heights and with various frames to help you decorate functional, aesthetic, and sustainable spaces that are inspired by modern life.

Los taburetes de la colección Coma se caracterizan por su diseño ligero y sus amplias opciones de acabados que se ajustan a todos los ambientes y entornos. Coma está disponible en distintas alturas y estructuras para decorar espacios funcionales, estéticos y sostenibles inspirados en la vida de hoy.

Coma Central Column

Coma Central Column stool medium in Teja Pantone 174 with polypropylene seat in Teja PP036.



Coma 4L Wood

Coma 4L Wood stool low with a fully upholstered shell in Era CSE41.
LTS rounded-square table bases in natural oak with LTS rounded-square oak table top.





Coma 4L Wood stools low with fully upholstered shells in Era CSE41.
LTS rounded-square table bases in natural oak with LTS rounded-square oak table top.
Noa 4L Wood chairs with fully upholstered shells in Divina Melange 917.



Coma 4L Wood stool medium, fully upholstered in Seattle ES042.

Coma Spin



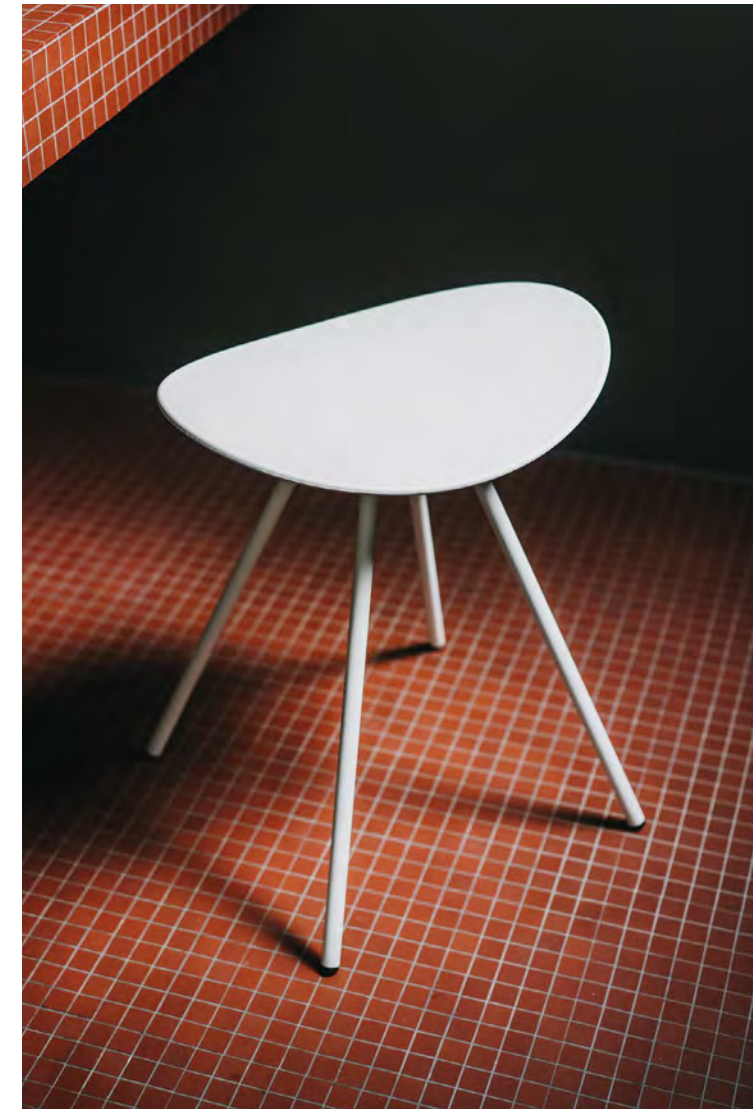





Coma 4L Wood stool low with wooden seat. Coma Spin stool high in Ocean Pantone 7545 with polypropylene seat in Ocean PP031.
Coma Central Column stool high in Ocean Pantone 7545 with a fully upholstered shell in Main Line Flax MLF51.

Coma 4L Wood Stool medium with front upholstery in Plus FR PLA157. Coma Spin Stool low in Ocean Pantone 7545
with a fully upholstered shell in Plus FR PLA173.

Coma Stools

Coma Stool Central Column Low, Medium & High

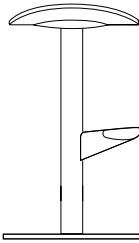

Coma Stool 4L Wood Low, Medium & High

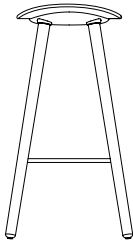

Coma Stool Spin Low, Medium & High

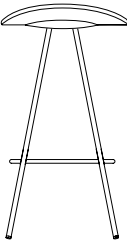

Shells

Wooden seat

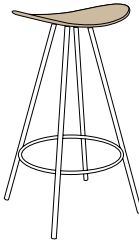

Polypropylene seat

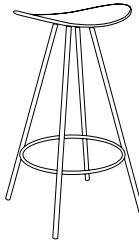

Front upholstery

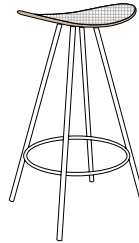

Fully upholstered

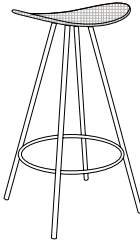

Learn more about the collection by scanning this QR code.



Punto

By Llusà Design

The Punto table collection offers a smart solution for public spaces, with a lightweight appearance that makes it especially resistant, minimalist, and sober. Punto is ideal for cafés, bars, restaurants and hotels, and can also fit perfectly into more corporate environments.

La colección de mesas Punto ofrece una solución inteligente para espacios públicos, con una apariencia ligera que la hace especialmente resistente, minimalista y sobria. Es perfecta para cafeterías, bares, restaurantes y hoteles, así como para entornos corporativos.

Punto Table Bases

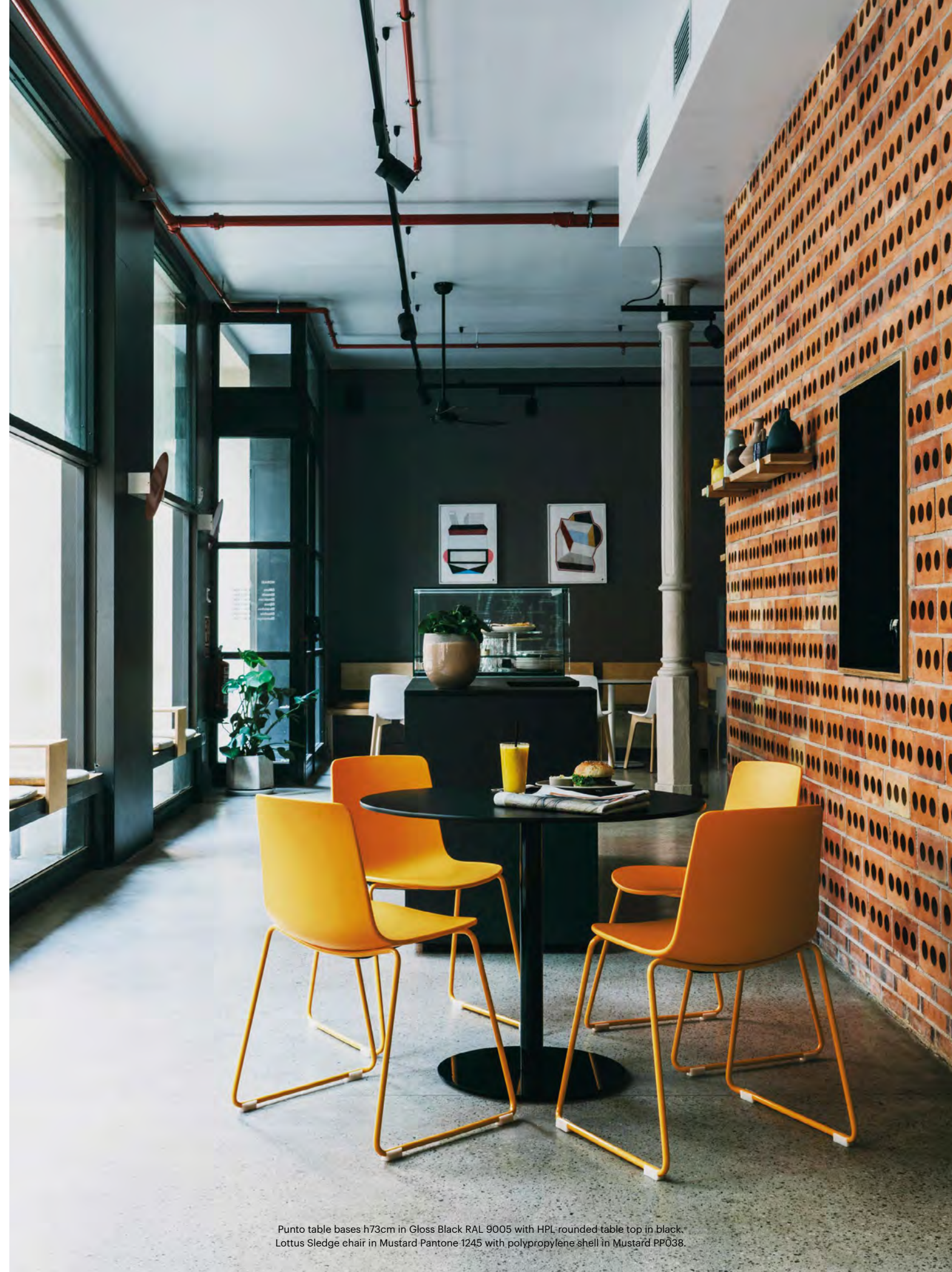





Punto Table Bases

Punto Table Bases Square

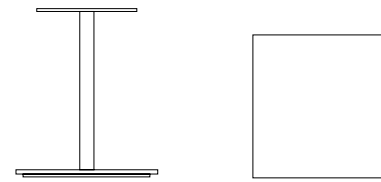

Punto Table Bases Round

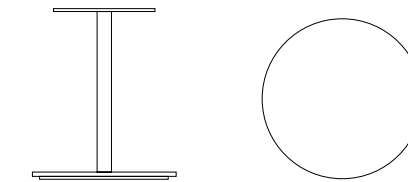

Enea Medium Table Top

Enea Medium Table Top Square

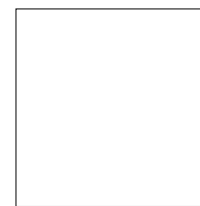

Enea Medium Table Top Round

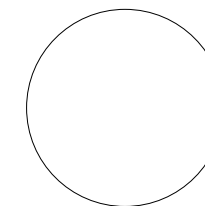

Learn more about the collection
by scanning this QR code.



Eina

By Llusca Design

Eina portrays our firm commitment to durable and high-quality manufacturing. This exceptionally solid and robust chair does not sacrifice on comfort. It is the perfect choice for a wide range of spaces, including classrooms, conference and concert halls, and spaces in the contract sector.

Eina exhibe nuestro firme compromiso con la fabricación duradera y de alta calidad. Esta silla excepcionalmente sólida y robusta no sacrifica la comodidad. Se convierte en una elección perfecta tanto para el sector contract como para aulas, salas de conferencia y auditorios.

Eina 4L



Eina 4L chair in White RAL 9016 with polypropylene shell and seat in White PPO03.
Eina 4L chair in Grey RAL 7004 with polypropylene shell and seat in Black PP400.



Eina



Eina 5R



Eina 5R chairs in Gloss White RAL 9016 with fully upholstered shells in Fame 66133 and 67068.
Way table bases in White RAL 9016 with HPL white table top.



Eina 4L Stool





Eina Modular Benches



Eina Chairs

Eina 4L Chair

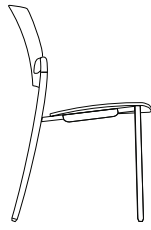

Eina 4L Chair with arms



Eina 5R Chair



Eina 5R Chair with arms



Eina Stools

Eina 4L Stool

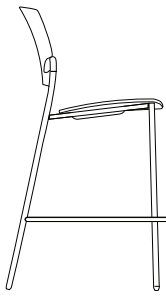

Eina 4L Stool with arms

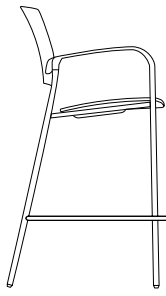

Eina Modular Benches

Eina Modular Benches 2 places

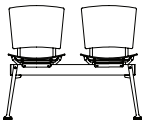

Eina Modular Benches 2 places with arms

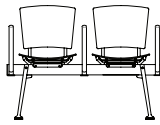

Eina Modular Benches 2 places with side arms

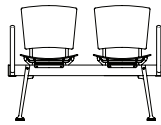

Eina Modular Benches 3 places

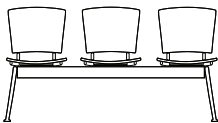

Eina Modular Benches 3 places with arms

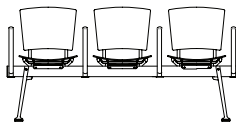

Eina Modular Benches 3 places with side arms

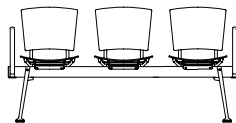

Eina Modular Benches 4 places

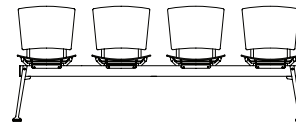

Eina Modular Benches 4 places with arms

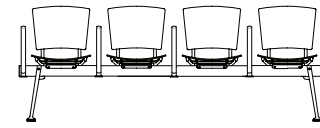

Eina Modular Benches 4 places with side arms

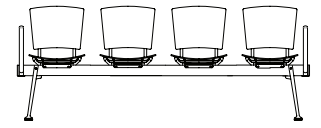

Eina Modular Benches 5 places

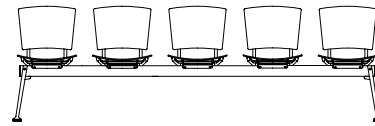

Eina Modular Benches 5 places with arms

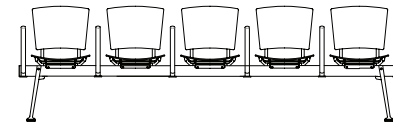

Eina Modular Benches 5 places with side arms

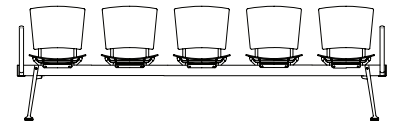

Chair, Stool & Modular Benches Shells

Polypropylene shell + seat

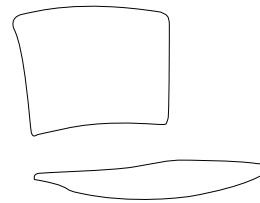

Polypropylene shell + upholstered seat

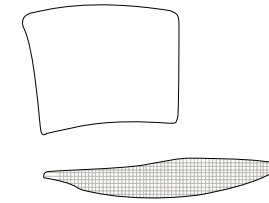

Fully upholstered

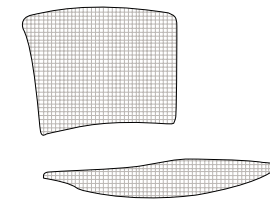

Learn more about the collection
by scanning this QR code.



Designers Diseñadores

Collaborating with top design studios has always been a fundamental part of Enea's essence.

Colaborar con los mejores estudios de diseño ha sido siempre una parte fundamental de la esencia de Enea.



Estudi Manel Molina

Created in 2016, Estudi Manel Molina combines the work of Manel Molina with that of Raimon Monsarro, Daniel Castro, and Blanca Roigé for the development of furniture, product, and communication projects. Manel Molina previously worked in the Miguel Milá studio, and founded Lievore Altherr Molina in 1991 alongside Alberto Lievore and Jeannette Altherr. He has developed industrial design, consultancy, and artistic direction projects for companies all around the world.

Creado en 2016, Estudi Manel Molina combina la labor de Manel Molina con la de Raimon Monsarro, Daniel Castro y Blanca Roigé para desarrollar proyectos de mobiliario, producto y comunicación. Manel Molina trabajó previamente en el estudio Miguel Milá y fundó en 1991 Lievore Altherr Molina junto con Alberto Lievore y Jeannette Altherr. Ha desarrollado trabajos de diseño industrial, asesoría y dirección artística para empresas de todo el mundo.



Llusçà Design

Josep Llusçà (Barcelona, 1948) studied Industrial Design at the Eina School in Barcelona, and later expanded his education at L'École des Arts et Métiers in Montreal. He created his own studio in 1972, specialising in lighting and furniture. Llusçà's products have won important awards throughout his career: the Industrial Design Excellence Award, the IF Product Design Award for Excellence in Design, the Red Dot Award, and Best of NeoCon, among others. In 1990, he received the National Design Award in recognition of his illustrious career.

Josep Llusçà (Barcelona, 1948) estudió Diseño Industrial en la escuela Eina de Barcelona y amplió su formación en L'École des Arts et Métiers de Montreal. Creó su propio estudio en 1972, especializándose en iluminación y mobiliario. Sus productos han merecido reconocimientos como el Industrial Design Excellence Award, el IF Product Design Award for Excellence Design, Red Dot Award y Best of NeoCon, entre otros. En reconocimiento a toda su carrera, Josep Llusçà obtuvo el Premio Nacional de Diseño en 1990.



Lievore Altherr Molina

The studio Lievore Altherr Molina was founded in 1991 as a result of the collaboration between Alberto Lievore, Jeannette Altherr, and Manel Molina. From their very beginnings, they embraced a humanistic approach that manifests itself in their dedication to creating forms of unparalleled beauty and purity. These forms emerge from the demands and limitations imposed by functional, technological, and contextual elements. Their work has been exhibited and recognised at international level.

El estudio Lievore Altherr Molina se estableció en 1991 como resultado de la colaboración entre Alberto Lievore, Jeannette Altherr y Manel Molina. Desde su inicio, abrazaron un enfoque humanístico que se manifiesta en su dedicación a la creación de formas de belleza estética y pureza incomparables. Estas formas emergen a partir de las demandas y limitaciones impuestas por elementos funcionales, tecnológicos y contextuales. Su obra ha sido tanto exhibida como reconocida a nivel internacional.



Gabriel Teixidó Sabater

Gabriel Teixidó was born in Barcelona in 1947. With over thirty years' experience, he is responsible for countless design creations and important awards. He is one of the most highly recognised Spanish designers in the industry. His way of working alone results in austere designs which are far from formal exhibitionism. Upholstered furniture, lighting, and office equipment are some of his specialities that have earned him awards such as SIDI and Delta. He is a designer devoted to the companies that he collaborates with, and likes to boast about just how profitable his designs have been for them.

Gabriel Teixidó, nacido en Barcelona en 1947 y con más de treinta años de trayectoria, cuenta con innumerables creaciones de diseño e importantes premios. Se trata de uno de los diseñadores españoles más reconocidos del sector. Su forma de trabajar, en solitario, da como fruto unos diseños austeros y alejados del exhibicionismo formal. El mueble tapizado, la iluminación y el equipamiento para oficinas son algunas de sus especialidades y le han valido galardones como el SIDI y Delta. Es un diseñador apegado a las empresas con las que colabora y presume de que sus diseños han sido rentables para ellas.

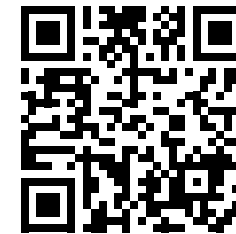

Visit our website to know more
about Enea

Brand Strategy: Breaking Molds

Art Direction: Asier Belloso

Creativity: Breaking Molds

Photography: Silvia Gil-Roldán, Alex Iturralde, Salva Lopez, Nor Studio, Yosigo

CGI: Kimu Studio, Alga Studio

Printing: Ganboa

Edition: January 2025

Ola Auzoa, 4
20250 Legorreta, Gipuzkoa
T. +34 943 806 275
www.eneadesign.com
@eneaofficial